

# MOTOMA®

Power into the Future



## USER MANUAL



**Please read this instruction manual carefully before using**

## **Contents**

1. Overview .....	5
2. Product Description.....	5
2.1. Product Features .....	5
2.2. Product List.....	5
3. Safety Instruction .....	5
3.1. Label Description .....	5
3.2. Installation tools .....	7
4. Energy Storage System Introduction .....	12
4.1. System Diagram .....	12
4.2. Technical Parameters.....	13
4.3. Product Dimension .....	14
5. Installation.....	18
5.1 Packing List .....	18
5.2. Installation Space.....	20
5.3. Installation Procedures .....	21
5.4. RBMS Output Connection .....	25
5.5. HE BESS Parallel Connection.....	25
5.6. AC Input.....	25
5.7. Checking Status .....	26
6. Communication Debugging .....	26
6.1. Dial Switch Settings .....	27
6.2. CAN/RS485 .....	28
6.3. Dry Contact Connection .....	29
7. Operation Test .....	29
7.1. Start-up Checking .....	29



7.2. SOC Validation & Calibration .....	29
7.3. Start-Up Steps.....	29
8. Troubleshooting.....	31
8.1. Troubleshooting List .....	31
8.2. Maintenance .....	34
9. Limitation of Liability .....	35
10. Storage.....	35

■ Term Definition

BMS	Battery Management System
SOC	State of Charge
SOH	State of Health
UPS	Uninterruptible Power Supply
OT	Over Temperature
OV	Over Voltage
UV	Under Voltage
Charge OC	Charge Over Current
Discharge OC	Discharge Over Current
Cell OV	Cell Over Voltage
Pack OV	Pack Over Voltage
LFP	LiFePO4
RBMS	Cluster Battery Management System
SBMS	System(Cluster)Battery Management System
BESS	Battery Energy Storage System

## 1. Overview

User Manual introduces the product's installation, operation, maintenance etc., which is suitable for high-voltage lithium battery system, the product are widely used in UPS backup power, large energy storage and other applications.

## 2. Product Description

MOTOMA provides safe and reliable lithium-ion battery energy storage system solutions for C&I, UPS, photovoltaic power generation systems, etc.

### 2.1. Product Features

The features of Lithium ion battery energy storage system are shown as below:

- Good compatibility
- High reliability
- Perfect stability
- Excellent safety performance
- Long service life

### 2.2. Product List

Packing list are as following:

No.	Items	Qty.(pcs)	Remark
1	Battery module	Upon Request	
2	RBMS	1	
3	Cabinet	1	
4	Power cables	2	Optional
5	Communication cable	2	Optional













## 3. Safety Instruction

### 3.1. Label Description

In order to ensure the users safety during operation, the Manual provides pertinent identification information and corresponding symbols.













Please read carefully the following list of symbols used in this Manual.

#### Safety symbols

	Low potential danger: it may result in mild or moderate injury
	High risk of serious injury or death
	High voltage inside the cabinet: a touch may lead to electric shock danger
	Wear safety goggles during installation or maintenance all the time
	Service by properly trained and qualified personnel only Disconnect charger and Verify no-voltage before maintenance Turn off the battery system and Lock-out/Tag-out before maintenance
	Recycle lithium-ion batteries
	Firmly ground to ensure the safety of operators and protect the grounding terminal (PE)
	Emphasis and supplement: a quick way to master this step
	Wear professional protective equipment to prevent personal injury.
	Do not dispose in trash, follow local regulations and manufacturers instruction
	Servicing of batteries must only be performed or supervised by qualified personnel knowledgeable of batteries and the required precautions. Keep unqualified personnel away from batteries.
	Wear professional protective equipment to prevent personal injury.
	Do not dispose of batteries in a fire as they can explode

### 3.2. Installation tools

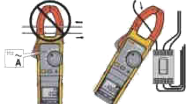
Tools should be prepared before installation are as follow:

Items	Tools		
Protection	Multi-meter 	Protective Gloves 	Insulated shoes 
	ESD wrist strap 	Safety goggles 	
Installation	Screw driver 	Cross head screwdriver 	Socket spanner 
	Slot type screwdriver 	wire stripper 	
Test	Clamp meter 	Laptop 	

## Attentions

### 3.3.1 Safety Warning Label

In the process of installation, daily maintenance, overhaul and other operations of high voltage series products, to prevent improper operation, by not skilled person and accidents, the following agreements must be noticed:

- The front and rear DC-breaker of products should be clearly marked to prevent accidents caused by false switching.
- Set up warning signs or safety warning belts near the operation area to keep irrelevant personnel out.
- After maintenance and overhaul, pull out the key to the cabinet door and keep it properly.

### 3.3.2 Personnel Requirement

- Only qualified personnel can carry out various operations on the product.
- Operators should be fully familiar with the system composition and working principles of entire high voltage series products.
- The operator should be fully familiar with the User Manual of the product.

### 3.3.3 Battery Protection

	<p>There is a deadly high voltage in the energy storage backup battery between the positive and negative poles of the battery system!</p> <p>During installation or maintenance, make sure that the connection between the battery pack and the UPS (inverter/PCS) is completely disconnected.</p>
---	--

### 3.3.4 Electric Measurement

	<p>After the installation of the energy storage backup battery, there is a high voltage. An accidental contact with the positive and negative poles may lead to deadly injury. Therefore, please watch out when you need to measure the power.</p> <ul style="list-style-type: none"><li>-Prepare for insulation protection (e.g. wearing insulating gloves, etc.)</li><li>-To ensure personal safety, the operator must be accompanied by others.</li></ul>
---	--

### 3.3.5 Expert Users Measuring Instrument

To ensure that the electrical parameters meet the requirements, relevant electrical measuring equipment should be used during the electrical connection and trial operation of the MOTOMA system.

	<p>The measuring equipment with appropriate measuring range should be in line with the on-site working conditions.</p> <ul style="list-style-type: none"><li>-Ensure correct and standard electrical connection of the instrument. Avoid the arc danger.</li></ul>
---	--

### 3.3.6 Maintenance and Repairing

	<p>After disconnecting the energy storage battery cabinet and UPS (inverter/PCS), confirm the disconnection again before opening the front door for maintenance or overhaul.</p>
---	--

In the maintenance and overhaul, the following items should be concerned:

- Ensure that the energy storage battery cabinet is not accidentally recharged.
- Ensure no electricity in the energy storage battery cabinet with a multi-meter.
- Insulate the possible electric part of MOTOMA with insulation materials. Insulate the bare metal part of the operating tool and the positive and negative terminal of the battery module with insulating tape.
- Ensure necessary ground connection.

### 3.3.7 Safety Notice

 <p>DANGER</p>	<p><b>HAZARD OF ELECTRIC SHOCK, EXPLOSION, OR ARC FLASH</b></p> <p>Read all instructions in the installation manual before installing or working on this product.</p> <p>Failure to follow these instructions will result in death or serious injury.</p>
---	---



DANGER

**HAZARD OF ELECTRIC SHOCK, EXPLOSION, OR ARC FLASH**

Install the product in a temperature controlled indoor environment free of conductive contaminants and humidity.

Install the product on a non-flammable, level and solid surface (e.g. concrete) that can support the weight of the system.

Failure to follow these instructions will result in death or serious injury.



DANGER

**HAZARD OF ELECTRIC SHOCK, EXPLOSION, OR ARC FLASH**

Batteries can present a risk of electric shock and high short-circuit current. The following precautions must be observed when working on batteries

Remove watches, rings, or other metal objects.

Use tools with insulated handles.

Wear protective glasses, gloves and boots.

Do not lay tools or metal parts on top of batteries.

Disconnect the charging source prior to connecting or disconnecting battery terminals. Only expert personnel can open the module.

Determine if the battery is inadvertently grounded. If inadvertently grounded, remove source from ground. Contact with any part of a grounded battery can result in electric shock. The likelihood of such shock can be reduced if such grounds are removed during installation and maintenance (applicable to equipment and remote battery supplies not having a grounded supply circuit).

Failure to follow these instructions will result in death or serious injury.





DANGER

**HAZARD OF ELECTRIC SHOCK, EXPLOSION, OR ARC FLASH**

Do not drill or cut holes for cables or conduits with the gland plates installed and do not drill or cut holes in close proximity to the product.

Failure to follow these instructions will result in death or serious injury

 <p>DANGER</p>	<p>The product is not designed for and must therefore not be installed in the following unusual operating environments:</p> <p>Damaging fumes</p> <p>Explosive mixtures of dust or gases, corrosive gases, or conductive or radiant heat from other sources</p> <p>Moisture, abrasive dust, steam or in an excessively damp environment</p> <p>Fungus, insects, vermin</p> <p>Salt-laden air or contaminated cooling refrigerant</p>
---	--

 <p>DANGER</p>	<p><b>HAZARD OF ELECTRIC SHOCK, EXPLOSION, OR ARC FLASH</b></p> <p>When replacing battery modules, always replace them with the same battery module type</p> <p>Failure to follow these instructions will result in death or serious injury</p>
---	---

 <p>DANGER</p>	<p>Electrical equipment must be installed, operated, serviced, and maintained only by expert users.</p> <p>Apply appropriate personal protective equipment (PPE) and follow safe electrical work practices.</p> <p>Turn off all power supplying the UPS system before working on or inside the equipment.</p> <p>Before working on the UPS system, check for hazardous voltage between all terminals including the protective earth.</p> <p>The battery cabinet contains an internal energy source. Hazardous voltage can be present even when the UPS system is disconnected from the utility/ mains supply. Before installing or servicing the UPS system, ensure that the units are OFF and that utility/mains and batteries are disconnected.</p> <p>A disconnection device (e.g. disconnection circuit breaker or switch) must be installed to enable isolation of the system from upstream power sources in accordance with local regulations. This disconnection device must be easily accessible and visible.</p> <p>The battery cabinet must be properly earthed/grounded and due to a high leakage current, the earthing/grounding conductor must</p>
---	---

	<p>be connected first.</p> <p>Failure to follow these instructions will result in death or serious injury.</p>
NOTICE	<p><b>RISK OF EQUIPMENT DAMAGE</b></p> <p>Batteries should not be stored beyond 12 months from the date of production. If they are stored for longer the calendar degradation will cause the batteries to be irreversible degraded beyond what is expected-a reduced runtime will be the consequence.</p> <p>If the UPS system remain DE-energized for a long period, MOTOMA recommends to shut down the batteries cabinet completely.</p> <p>Failure to follow these instructions can result in equipment damage.</p>

**Note:** this label can be design according to customer requirement

## 4. Energy Storage System Introduction

High voltage system integrated with the module, high-precision BMU units monitor and gather real-time module voltage and temperature, to realize intelligent temperature control at electric core level and intelligent balance of battery cell, which improves system efficiency and battery cycle life. The module is designed by filling the inside of the cold-rolled sheet metal shell, achieving high safety and reliability. At the same time, the module is designed with high stability and disturbance immunity, to ensure the safe and reliable operation of the battery cluster after it is integrated into the system.

### 4.1. System Diagram

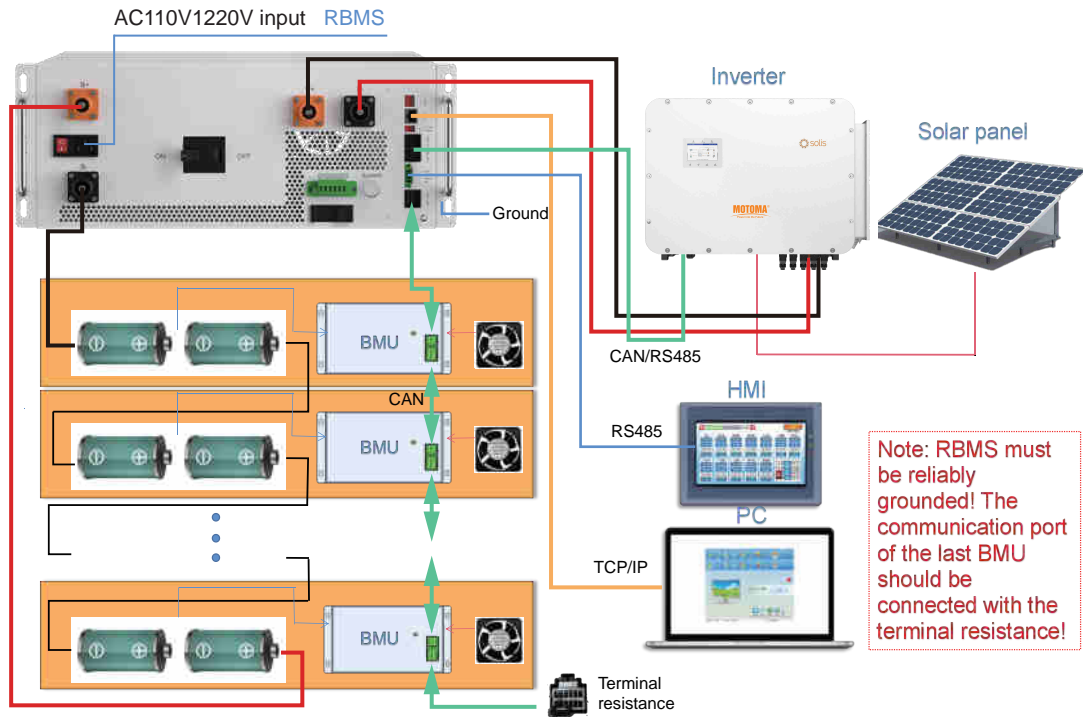

## 4.2. Technical Parameters

Cell Chemistry	LiFePO4		
Module Nominal Voltage(V)	51.2		
Module Capacity(Ah)	314		
Module Energy(kWh)	16.07		
Battery Module Qty <sup>1</sup> in Series	12	13	15
System Nominal Voltage (V)	614.4	665.6	768
Charge Voltage (V)	691.2	748.8	864
Cut-Off Discharge Voltage(V)	537.6	582.4	672
Float Charge Voltage(V)	662.4	717.6	828
System Energy (kWh)	192.9	208.9	241.1
Charge Current <sup>2</sup> (A)	Max. Charge Current: 150A		
	Recommended Charge Current: 50A		

Discharge Current (A)	Max.Discharge Current:150A
	Recommended Discharge Current:50A
Temperature (°C)	Charge: 0~55°C
	Discharge: -20~60°C
	Storage:0-45°C
Status Indicator	RUN-Green Light;Alarm-Red Light
Communication Port	CAN/RS485
IP Rating of Enclosure	IP55
Dimension (W/D/H, mm)	1666×1414×2310
Installation Location	Outdoor
Storage Temperature (°C)	0-45°C
Recommend Depth of Discharge	90%

### 4.3. Product Dimension

Items	ESS-M92-193	ESS-M100-209	ESS-M120-241
Length(mm)	1666		
Depth(mm)	1414		
Height(mm)	2310		



## BMS

### 4.3.1 RBMS Description

RBMS system consists of two levels of architecture. The cabinet-level management system is Cabinet BMS, hereinafter referred to as BMU. RBMS is responsible for battery current detection, data collection and analysis, alarm and protection control, communication with upper and lower levels, etc. RBMS consists of main circuit breaker, charging and discharging double-loop control switch circuit, high-voltage isolation detection circuit, parallel processing circuit, high-voltage power supply and DC starting circuit, RBMS chassis and related wiring harness. State management and action protection of over charge, over discharge, over current, short circuit can realize and ensure the safety and reliability of the whole system.



#### 4.3.4 RBMS specification





Interface	Description	Remark
GBMS/ UPS	The interface of COM1 COM2 shown in Figure 2.0 communicates with GBMS (when used in parallel)/UPS (when used in non-parallel connection)	RS485/CAN communication
LAN	Interfaces of the LAN shown in Figure 2.0	update the BMS program and view the data through this interface
BMU	Interface of BMU shown in Figure 2.0	Communicate with the battery module BMU through the CAN interface
ID	Set the communication ID of CBMS (when used in parallel) Pin 1 dial to ON ID+1 Pin 2 dial to ON ID+2 Pin 3 dial to ON ID+4 Pin 4 dial to ON ID+8	1 to 4 digits of the DIP switch
CAN_R	whether the CAN communication terminal resistance of CBMS is valid (120R) when it is set	DIP switch
485_R	whether the RS485 communication terminal resistance of CBMS is valid (120R)when it is set	DIP switch
Switch on	Circuit breaker opening and closing indicator light	Red color
Status	System Status Indicator	red and green color
AC Power	AC start input, voltage range 85~264VAC	AC power supply use
DC Start	DC start button, voltage range 254~780VDC	Used during DC start
DC24V-Out	DC 24V output	Power the GBMS









I1/I2	NC	NC
B+ B-	Cables terminal	B+: battery positive terminal B-: battery negative terminal
P+ P-	Output terminal	P+: power output positive P-: power output negative



## 5. Installation

### 5.1 Packing List

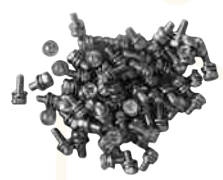
Checking the packing list before installation, make sure the parts are completely.

Name	Specifications	Number	Image
Battery connection cable	Battery B- B +	2	
Battery connection cable	orange	7	
Battery connection cable	Orange	6	
Battery connection cable	Orange	1	
Out power cable	orange cable	1	

Out power cable	black cable	1	
Out Communication cable	MOTOMA cable	1	
Out Communication cable	DEYE cable	1	
BMU communication cable	BMU communication cable	13	
BMU communication cable	BMU communication cable	2	
Ground cable	Ground cable	15	
Screw	Screw	N	
User Manual	User Manual	1	

Warranty Card	Warranty Card	1	
AC socket (Wiring available)	250V 10A	1	
Dry contact terminal	5.08-6Pin	1	
Terminal resistance	120R	1	
Mounting plate	Suitable for use with other inverters.	1	

## 5.2. Installation Space

The installation location of lithium battery plays a key role in its safety, service lifetime and performance. The system should be installed in a place allowed for convenient wiring, easy maintenance and easy operation.



## 5.3. Installation Procedures

Have to make sure the battery off and all equipment are off when install the battery module

### 5.3.1 Battery cabinet installation

When you installation,pls check the cabinet parts list whether if right.

#### **cabinet installation step**

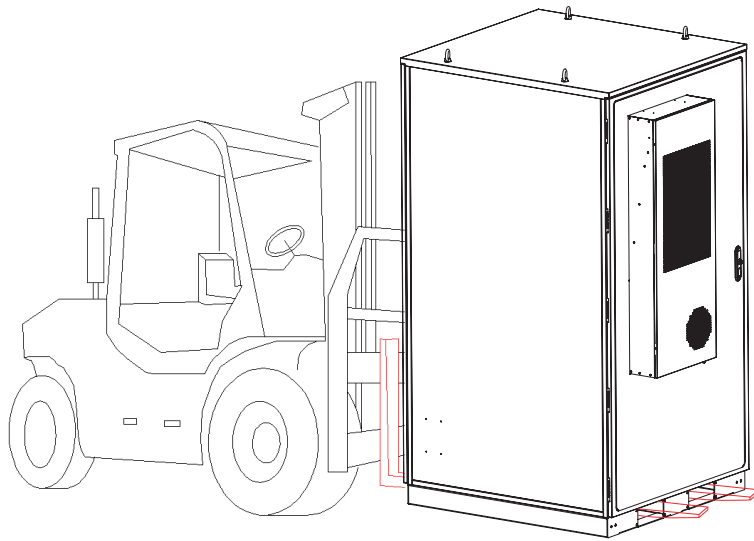

- 1.This product is an outdoor box structure designed with forklift specific ports ( front and back )
- 2.This product can only be transported by forklift (if lifting is necessary, please use specialized lifting equipment);
- 3.The installation site should have forklift and lifting operation requirements;
- 4.Recommend using forklifts weighing over 3 tons for operation;
- 5.The weight of this product is 2100kg.

**Note: This product should be installed and stored on a flat and hard surface to avoid tilting; There should be no protrusions on the bottom floor of the product to avoid deformation and damage to the equipment.**

This product is an outdoor product, and the installation and storage site is open outdoors, away from crowds or other animal activity areas.

## Foundation Construction Instructions

- 1.The site should be compacted and leveled.
- 2.The cement foundation should use C25 material.
- 3.The portion of the foundation below the ground should be no less than 100mm.
- 4.During concrete pouring, expansion bolts must be accurately embedded in advance according to the dimensions specified in the drawings
- 5.After the cement pouring is complete, it should be cured for more than 7 days before installing the equipment.

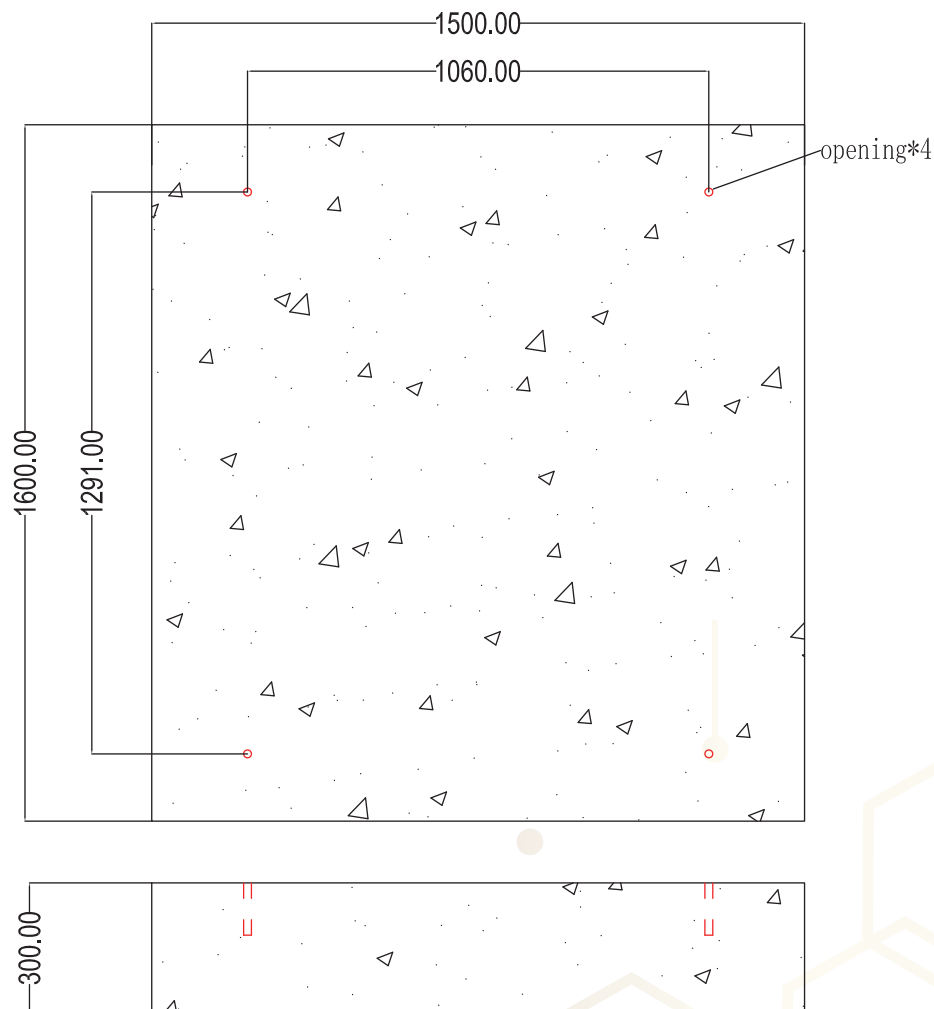

### 5.3.2 Connect the BMU Communication Cable and power cable

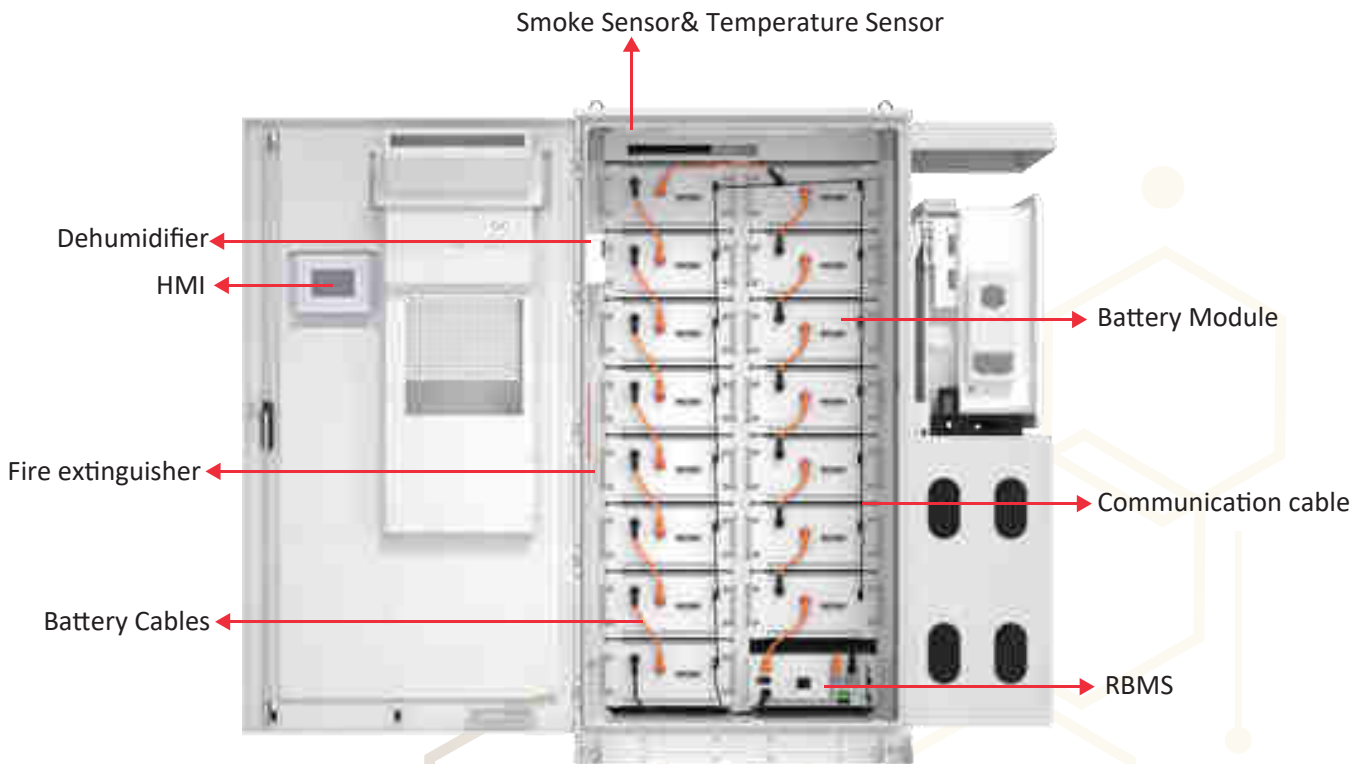

### 5.3.3 RBMS COM1/COM2 Connect to Inverter/PCS Communication Port

(CAN or RS485)

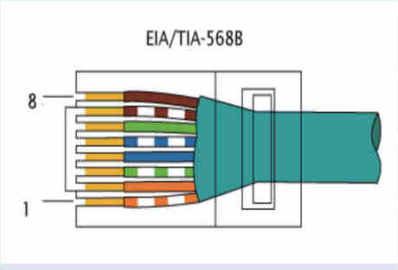
	Pin	Signal
 <p>EIA/TIA-568B</p>	1	Reserved
	2	CAN_GND
	3	Reserved
	4	CAN_H
	5	CAN_L
	6	485_GND
	7	RS485_A
	8	RS485_B

CAN communication

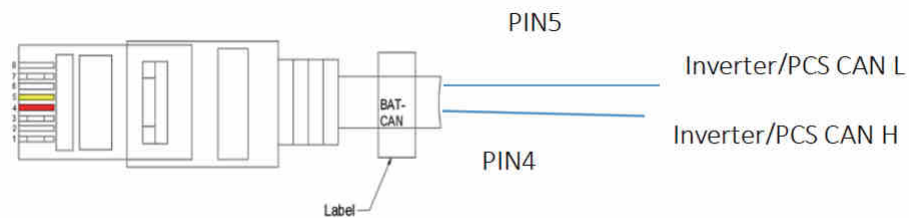

RS485 communication

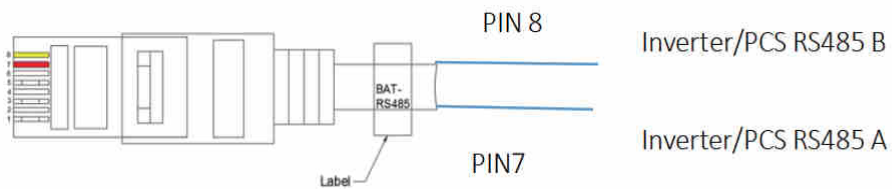

## 5.4. RBMS Output Connection

RBMS P+ P- connect to inverter B + , B-



## 5.5. HE BESS Parallel Connection

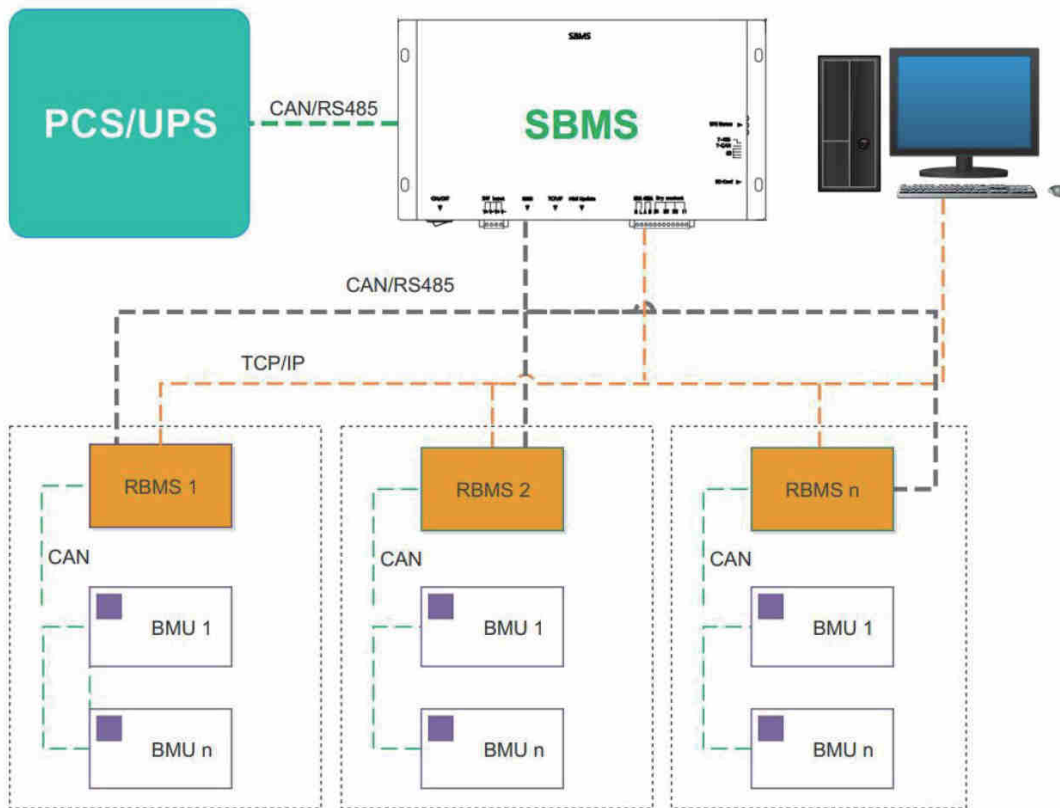

## 5.6. AC Input

When all battery and RBMS connect completely, connect to AC 220V power supply UPS or other input equipment to bus-bar

## 5.7. Checking Status

When all battery and RBMS installed and connected, start to check the battery normal or not. If everything normal, go to next step. If still have some problems, need check it further.

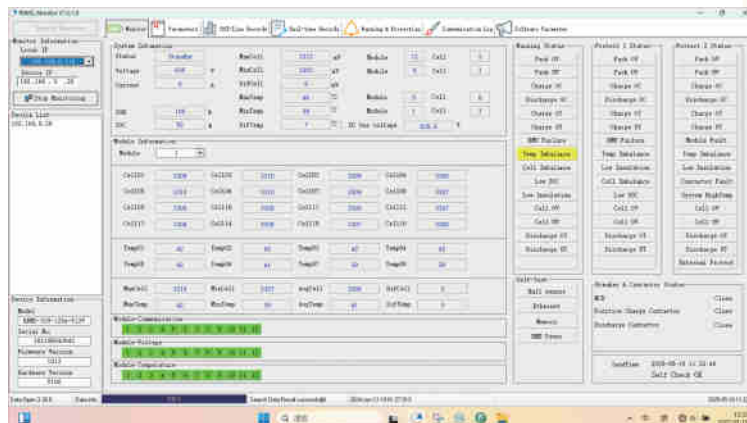

If parallel connection, please double check if the capacity and module number are correct

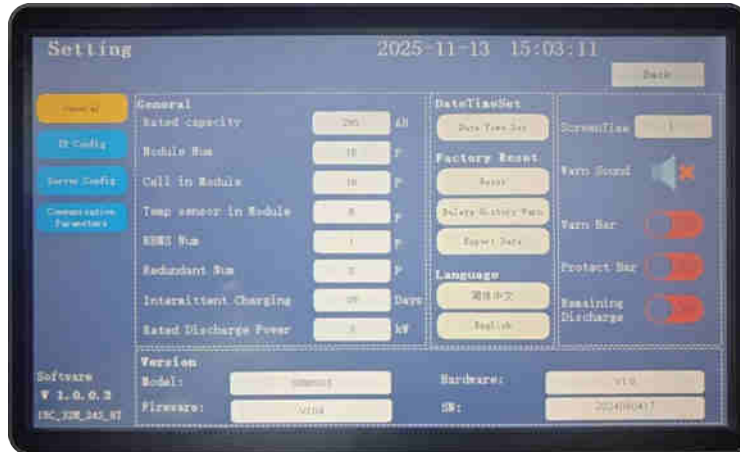

**Note:** When systems are connected in parallel, it is needed to update CBMS & SBMS software.



## 6. Communication Debugging

### 6.1. Dial Switch Settings

In order to ensure the overall stability of the system, the parallel communication of lithium battery system adopts CANBUS mode. In order to distinguish the address access of its equipment for communication during the parallel state, it is necessary to set reasonable addresses of different equipment through the dial code switch on the CBMS panel to ensure the communication quality so as to facilitate the differential access of SBMS/ upper computer, as shown in the figure. The dialing address of CBMS should start from 1, because 0 is used as the broadcast address.

#### DIP Dial Code

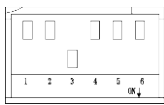
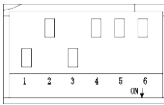
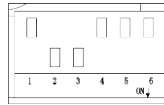
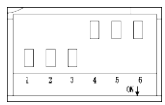
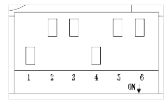
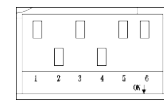
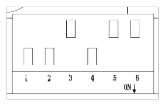
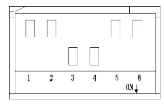
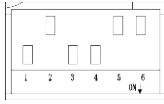
		<p>The dial-code switch is DIP switch, which is effective when dialed to ON side, indicating that the switch is ON, The four ID dial code keys are independent, for 0/1 binary encoding, 4 ID dial code a total of 16 encoding definition address.</p>	
<p>ID: 0</p>	<p>ID: 1</p>	<p>ID: 2</p>	<p>ID: 3</p>

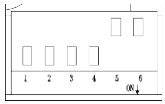
 ID: 4	 ID: 5	 ID: 6	 ID: 7
 ID: 8	 ID: 9	 ID: 10	 ID: 11
 ID: 12	 ID: 13	 ID: 14	 ID: 15

In general, the dial code of the lithium battery system connected to SBMS is 1, and the addresses of other cabinets are increased successively according to the above table. The system of the last address should enable can-r / 485-r functions, as shown in the figure below.

## 6.2. CAN/RS485

High voltage lithium ion battery system provides a variety of communication methods to meet the needs of users: CAN/RS485. The communication interface is unified and integrated on the integrated CBMS. CBMS is responsible for communicating with external equipment to realize information sharing.

### communication connect (CAN/MODBUS)

	The specification of CAN/RS485 communication cable shall be A shielded twisted pair, and the communication terminals are at the bottom of CBMS, respectively printed with B A/H L. Please select according to the actual communication requirements. If you have any questions about the communication protocol provided by our company, please contact our technical personnel in time.
---	--





When the lithium battery system works, it is controlled by BMS intelligently without the need for manual interference or control. When the lithium battery cabinet is working, the cabinet door should be locked tightly and the key of the door should be pulled out.

**Step 1:** Start installing batteries, ensure the battery power cables are connected correctly. Connect the cables according to COM1/COM2.

**Step 2:** Before starting the system, set the DIP codes of CBMS. Dip rules have been put in the manual.

**Step 3:** Double check the connection of cabinets are corrected

**Step 4:** Start the system. When powered on separately, check the self-check status of all systems.

**Step 5:** When the self-test is successful, a sound will appear, and the indicator light will turn green and keep on.

-If self-check fails, the indicator will keep red on. If the self-test fails, you need to check it.

-Is it determined that it is the cell voltage/temperature/communication failure/CBMS parameter.

-The alarm information can be observed on the monitor and display screen

Detect and repair voltage/temperature/communication faults, return to step 3 and retest in order

**Step 6:** Close all battery cabinets.

**Step 7:** Check whether the CBMS parameters are completely consistent. If it makes sense, go to the next step. If it doesn't, recheck and make changes.

**Step 8:** Check the dry contacts and verify that are reasonable. If it makes sense, go to the next step. If it doesn't, re-check and confirm the cause (Contact our technical to redefine dry contacts)

**Step 9:** Check whether the communication is normal, if it makes sense, go to the next step. If it doesn't, check the register configuration and verification and retest.

**Step 10:** Start UPS

**Step 11:** Check whether the communication is normal, if it makes sense, go to the next step. If it doesn't, check the register configuration and verification and retest

**Step 12:** Test the backup time, if it is satisfying, end the test. If not, troubleshoot abnormal causes: abnormal battery discharge etc.

## 8. Troubleshooting

### 8.1. Troubleshooting List

Fault Type	Cause	Solutions
Over Voltage	The DC voltage in the system exceeds the maximum setting value.	Check whether the charging voltage of the UPS terminal is reasonable. If the charging voltage of UPS exceeds the setting value, please contact the UPS manufacturer for solution. Check the maximum setting voltage of battery terminal, and check the protection parameters setting through LCD.
Under Voltage	The DC voltage in the system is below the minimum setting value.	Check the minimum setting voltage of the battery terminal, and check the protection parameters setting through LCD.
Charging Over Current	The system charging current exceeds the maximum setting current	1. Check whether the charging current of the UPS terminal is reasonable. If the charging current of UPS exceeds the setting value, please contact the UPS manufacturer for solution. 2. Check the maximum setting charging current at the battery end, and check the protection parameters setting through LCD.
Discharging Over Current	A short circuit occurs in the master control CBMS, or its internal components are damaged.	1. Check whether the output power of UPS terminal is overloaded, and whether the actual power conforms to the setting value. If the output power of UPS exceeds the setting value, please contact UPS manufacturer for solution. 2. Check whether there is any problem with the internal control circuit of the master control CBMS. Please also contact our company.

<p>Low Temperature Charging</p>	<p>Module temperature is below the minimum charging temperature.</p>	<p>Check the indoor environment temperature is reasonable or not. If it is, check the minimum charging temperature parameters set in the system, and check the protection parameters setting through LCD. When the temperature rises to the reasonable value, the battery will be recharged. After the above process, if the same problem repeats, completely power off the system and then check the battery module.</p>
<p>Low Temperature Discharging</p>	<p>The module temperature is below the minimum discharging temperature</p>	<p>Check the indoor environment temperature is reasonable or not. If it is, check the minimum discharging temperature parameters set in the system, and check the protection parameters setting through LCD. When the temperature rises to the reasonable value, the battery will be recharged and discharged. After the above process, if the same problem repeats, completely power off the system and then maintain the battery module.</p>
<p>Over Voltage of Cell</p>	<p>The voltage of cell exceeds the maximum setting voltage.</p>	<p>1、 Check the charging voltage of the UPS terminal and check the setting value is reasonable or not. If the charging voltage of UPS does exceed the setting value, please contact the UPS manufacturer for solution. 2、 Check the maximum setting voltage of cell, and check the protection parameters setting through LCD . After the above process, appropriately reduce the charging voltage to alleviate this phenomenon. Over voltage of cell is a normal phenomenon. Due to battery differences.</p>
<p>Under Voltage of Cell</p>	<p>The voltage is cell is below the minimum setting voltage.</p>	<p>Check the minimum setting protection voltage of cell, and check the protection parameters setting through LCD . If it is confirmed that setting parameters are reasonable and the single under-voltage protection occurs prematurely, please contact MOTOMA.</p>

Charging High Temperature	Module temperature exceeds the maximum charging temperature.	Discharge and check whether the charging time of the system is reasonable. If it is, completely power off the system, and overhaul the module and the cooling fan.
Discharging High Temperature	The module temperature exceeds the maximum discharging temperature.	Check whether the maximum setting discharging protection temperature of the battery is reasonable and check the protection parameters settings through LCD . If the setting discharging protection temperature is reasonable, completely power off the system, and overhaul the module and the cooling fan.
CBMS Fault	Parallel communication faults occur.	Check whether the network cable connected by CBMS is loose or correctly connected. If the connection is normal but the communication does not work, please contact MOTOMA.
Self-Check Failure after Power On/ Self-Check Failed	Internal communication faults occur.	Completely power off, and maintain the failure of communication between modules.
Fan Error	Fan is blocked or does not work.	Check whether the system works and whether there is blockage near fans. If so, remove the foreign material. If it still cannot work, completely power off the system and replace the fan.
LCD screen cannot start up or work	The power supply line of the display screen is loose. The communication cable is wrongly connected or loose.	Check whether all wiring works and is firmly connected (power supply line and communication line). Confirm whether the A/B line is connected correctly. If the above things are fine, please replace the LCD display screen or contact MOTOMA.

## 8.2. Maintenance

Maintain Items	Methods and standards	Maintenance period
Connection of Power Cable	<p>Check whether there is mechanical damage on the power cable; If the insulation wrapping of the terminal is falling off. If there is, it must be repaired or replaced.</p> <p>If the connection is loose, re-tighten it with standard torque.</p> <p>Check whether any screw is loose; whether there is color change in wiring copper bar.</p>	Once every six months
Connection of Communication Terminal	<p>Check whether the parallel communication network cable is loose. Please tighten it again with a screwdriver.</p> <p>Check whether there is any peeling or color change on communication cable. If so, it must be replaced.</p>	Once every year
Fan	<p>Check whether there is noise, fan clog or mechanical defect of the fan blade during operation. If so, replace the fan.</p>	Once every year
Cleaning System	<p>Check whether the front and back doors of the cabinet and modules are attached with dust. Please clean the outlet and the CBMS panel in time.</p>	Once every six months to one year
Running Status of System	<p>Check the monitor LCD panel for any abnormal faults.</p> <p>Expert users check whether all parameters are normal when the system is working (total voltage, insulation, etc.).</p> <p>Check whether the main components of the system are normal: the mechanical closure of circuit breaker switch works; the contactor is in good mechanical condition (including auxiliary switch), etc.</p> <p>Check whether the inlet and outlet ventilation duct of the system is normal and clean it in time.</p>	Once every six months
Charge & Discharge Maintenance	<p>Check whether SOC and SOH status of lithium battery system are normal, light load or shallow discharge and charge. Shallow discharge DOD: 10% is recommended.</p> <p>Check whether charging and discharging current and voltage collected by the system are consistent.</p>	Once every six months

	<p>Take good protective measures during maintenance. Wear insulating gloves and use insulating metal tools.</p> <p>At the end of maintenance, ensure the restoration of the objects that need to be removed, and ensure that all screws are fastened in place.</p>
---	--

## 9. Limitation of Liability

Liability exemption is shown as below:

- In the following cases, our company has the right not to provide quality assurance. Customers does not install, use or modify properly following this Manual.
- Product is damaged in transit.
- Product failure is caused by installation, replacement or unloading by non-relevant technical personnel or personnel not from our company.
- Product failure and damage caused by operating environment beyond manual specification or abnormal natural environment, such as floods, typhoons, earthquakes, etc.
- Product failure or damage caused by wrong operation or installation not in accordance with relevant standards.
- The products exceed the warranty period.
- For product failure or damage caused by the above reasons, if the customer requires replacement or maintenance services, we can provide corresponding paid services when our after-sales service confirm and evaluate the extent of damage.

## 10.Storage

- Short-term lithium storage: if the lithium battery is not used for a short period of time( $\leq 6$  months), the battery should be stored in  $20^{\circ}\text{C}\sim 35^{\circ}\text{C}$ ,  $35\%\sim 85\%$  (RH) non-denying environment.
- Long-term lithium storage: if the lithium battery is not used for a long time( $\geq 12$  months), the battery should be stored in  $20^{\circ}\text{C}\sim 35^{\circ}\text{C}$  &  $35\%\sim 85\%$  non-denying environment.
- Any battery stored for more than 12 months should be maintained to check the voltage of the battery. The voltage is less than 50.32V (3.145V/ battery), the SOC is less than 10% and requires 0.2C to be fully charged. The storage period begins from the date of entry into the warehouse.