

# MOTOMA<sup>®</sup>

Power into the Future

## USER MANUAL



**InfiniSolar WP 30KW 3P  
SOLAR INVERTER / CHARGER**

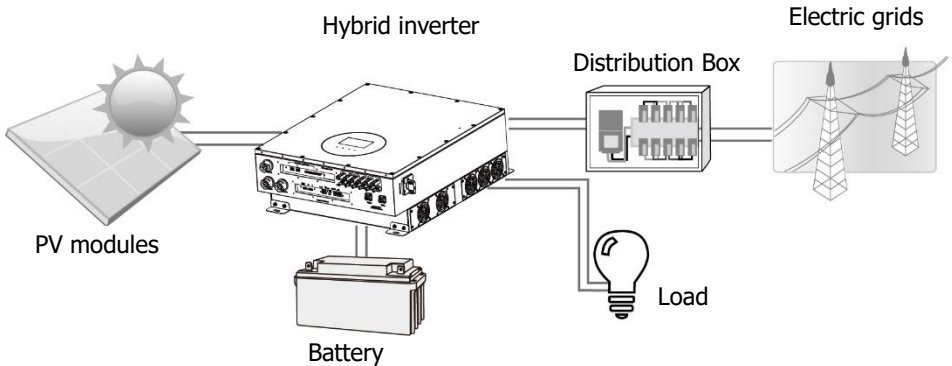
# Table Of Contents

1.	Introduction.....	1
2.	Important Safety Warning.....	2
3.	Unpacking & Overview .....	4
	3-1. Packing List.....	4
	3-2. Product Overview .....	4
4.	Installation .....	5
	4-1. Precaution .....	5
	4-2. Selecting Mounting Location.....	5
	4-3. Mounting Unit .....	5
5.	Grid (Utility) Connection .....	7
	5-1. Preparation .....	7
	5-2. Connecting to the AC Utility .....	7
6.	Generator Connection.....	9
	6-1. Preparation .....	9
	6-2. Connecting to the Generator input.....	9
7.	PV Module (DC) Connection .....	11
8.	Battery Connection.....	15
9.	Load (AC Output) Connection .....	16
	8-1. Preparation .....	16
	8-2. Connecting to the AC output .....	16
9.	Communication Connection .....	18
10.	Dry Contact Signal .....	20
	10-1. Electric Parameter .....	20
	10-2. Function Description .....	20
11.	Application with Energy Meter.....	22
12.	Commissioning.....	23
13.	Initial Setup .....	24
14.	Operation .....	36
	14-1. Interface.....	36
	14-2. LCD Information Define .....	36
	14-3. Button Definition .....	38
	14-4. LCD Setting.....	39
	14-5. Query Menu Operation.....	48
	14-6. Operation Mode & Display.....	55
15.	Charging Management .....	60
16.	Maintenance & Cleaning .....	62
17.	Trouble Shooting.....	63
	17-1. Warning List.....	63
	17-2. Fault Reference Codes .....	64
18.	Specifications.....	68

Appendix I: Parallel Installation Guide .....	70
Introduction.....	70
Parallel cable.....	70
Overview .....	70
Mounting the Unit .....	71
Wiring Connection.....	71
Inverters Configuration.....	73
Setting and LCD Display .....	75
Commissioning.....	78
Trouble shooting .....	79
Appendix II: BMS .....	80
Appendix III: Wi-Fi Operation Guide.....	81

# 1. Introduction

This hybrid PV inverter can provide power to connected loads by utilizing PV power, utility power and battery power.



**Figure 1 Basic hybrid PV System Overview**

Depending on different power situations, this hybrid inverter is designed to generate continuous power from PV solar modules (solar panels), battery, and the utility. When PV input voltage is within acceptable range (see specification for the details), this inverter is able to generate power to feed the grid (utility) and charge battery. This inverter is only compatible with PV module types of single crystalline and poly crystalline. Do not connect any PV array types other than these two types of PV modules to the inverter. Do not connect the positive or negative terminal of the solar panel to the ground. See Figure 1 for a simple diagram of a typical solar system with this hybrid inverter.

**Note:** Based on the EEG standard, every inverter sold to German area is not allowed to charge battery from Utility. The relevant function is automatically disabled by the software.

## 2. Important Safety Warning

**Before using the inverter, please read all instructions and cautionary markings on the unit and this manual. Store the manual where it can be accessed easily.**

This manual is for qualified personnel. The tasks described in this manual may be performed by qualified personnel only.

### General Precaution-

#### Conventions used:

**WARNING!** Warnings identify conditions or practices that could result in personal injury;

**CAUTION!** Caution identify conditions or practices that could result in damaged to the unit or other equipment connected.



**WARNING!** Before installing and using this inverter, read all instructions and cautionary markings on the inverter and all appropriate sections of this guide.



**WARNING!** Normally grounded conductors may be ungrounded and energized when a ground fault is indicated.



**WARNING!** This inverter is heavy. It should be lifted by at least two persons.



**CAUTION!** Authorized service personnel should reduce the risk of electrical shock by disconnecting AC, DC and battery power from the inverter before attempting any maintenance or cleaning or working on any circuits connected to the inverter. Turning off controls will not reduce this risk. Internal capacitors can remain charged for 5 minutes after disconnecting all sources of power.



**CAUTION!** Do not disassemble this inverter yourself. It contains no user-serviceable parts. Attempt to service this inverter yourself may cause a risk of electrical shock or fire and will void the warranty from the manufacturer.



**CAUTION!** To avoid a risk of fire and electric shock, make sure that existing wiring is in good condition and that the wire is not undersized. Do not operate the Inverter with damaged or substandard wiring.



**CAUTION!** Under high temperature environment, the cover of this inverter could be hot enough to cause skin burns if accidentally touched. Ensure that this inverter is away from normal traffic areas.



**CAUTION!** Use only recommended accessories from installer. Otherwise, not-qualified tools may cause a risk of fire, electric shock, or injury to persons.



**CAUTION!** To reduce risk of fire hazard, do not cover or obstruct the cooling fan.



**CAUTION!** Do not operate the Inverter if it has received a sharp blow, been dropped, or otherwise damaged in any way. If the Inverter is damaged, please call for an RMA (Return Material Authorization).



**CAUTION!** AC breaker, DC switch and Battery circuit breaker are used as disconnect devices and these disconnect devices shall be easily accessible.

**Before working on this circuit**

- Isolate inverter/Uninterruptible Power System (UPS)
- Then check for Hazardous Voltage between all terminals including the protective earth.



**Risk of Voltage Backfeed**

**Symbols used in Equipment Markings**

	Refer to the operating instructions
	Caution! Risk of danger
	Caution! Risk of electric shock
	Caution! Risk of electric shock. Energy storage timed discharge for 5 minutes.
	Caution! Hot surface

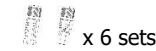
## 3. Unpacking & Overview

### 3-1. Packing List

Before installation, please inspect the unit. Be sure that nothing inside the package is damaged. You should have received the following items inside of package:



Inverter unit



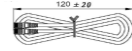
PV connectors x 6 sets



AC connectors



Fixing screws



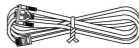
Parallel cable



Software CD



Manual



RS-232 cable

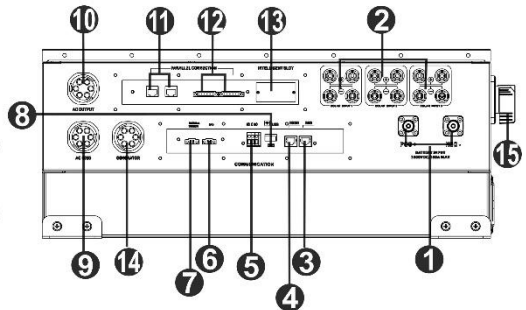
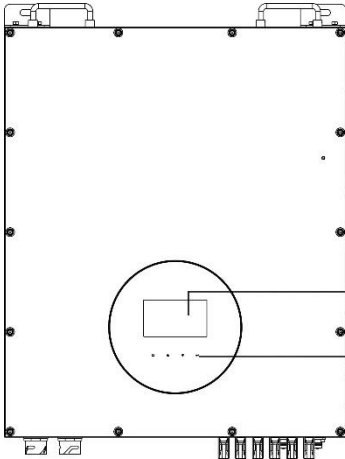


Share current cable



battery plugs

### 3-2. Product Overview



- |  |  |
|--|--|
| 1) Battery connectors                      | 11) Parallel communication port  |
| 2) PV connectors                           | 12) Current sharing port   |
| 3) BMS port                                | 13) Intelligent slot   |
| 4) RS-232 communication port               | 14) Generator input  |
| 5) Dry contact                             | 15) PV switch  |
| 6) EPO                                     | 16) LCD display panel (Please check section 10 for detailed LCD operation) |
| 7) Battery thermal sensor                  | 17) Touchable buttons  |
| 8) USB communication port                  |  |
| 9) AC Grid connectors                      |  |
| 10) AC output connectors (Load connection) |  |

## 4. Installation

### 4-1. Precaution

This Hybrid inverter is designed for indoor or outdoor use (IP65), please make sure the installation site meets below conditions:

- Not in direct sunlight
- Not in areas where highly flammable materials are stored.
- Not in potential explosive areas.
- Not in the cool air directly.
- Not near the television Antenna or antenna cable.
- Not higher than altitude of about 2000 meters above sea level.
- Not in environment of precipitation or humidity (>95%)

Please AVOID direct sunlight, rain exposure, snow laying up during installation and operation.

### 4-2. Selecting Mounting Location

- Please select a vertical wall with load-bearing capacity for installation, appropriate for installation on concrete or other non-flammable surfaces.
- The ambient temperature should be between  $-25\sim 60^{\circ}\text{C}$  to ensure optimal operation.
- Be sure to keep other objects and surfaces as shown in the diagram to guarantee sufficient heat dissipation and have enough space for removing wires.
- For proper air ventilation to dissipate heat, allow a clearance of approx. 50cm to the side and approx. 50cm above and below the unit. And 100cm toward the front.

### 4-3. Mounting Unit

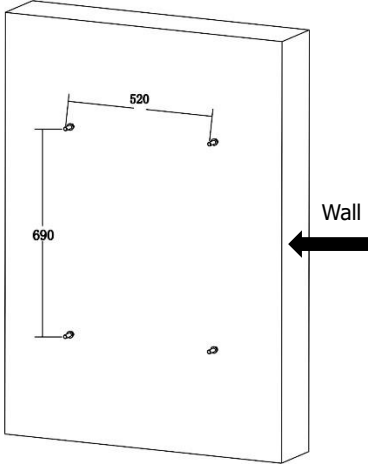
**WARNING!!** Remember that this inverter is heavy! Please be carefully when lifting out from the package.

Installation to the wall should be implemented with the proper screws. After that, the device should be bolted on securely.

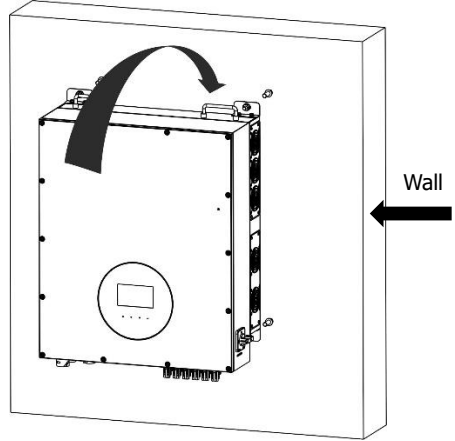
**WARNING!!** FIRE HAZARD.  
SUITABLE FOR MOUNTING ON CONCRETE OR OTHER NON-COMBUSTIBLE SURFACE ONLY.



1. Drill four holes in the marked locations with supplied four screws. The reference tightening torque is 35 N.m.



2. Fix the inverter on the wall.



3. Check if the inverter is firmly secured.

## 5. Grid (Utility) Connection

### 5-1. Preparation

**NOTE:** The overvoltage category of the AC input is III. It should be connected to the power distribution.

**NOTE2:** The inverter is built in a 63A/400V breaker to protect the inverter from AC power damage.

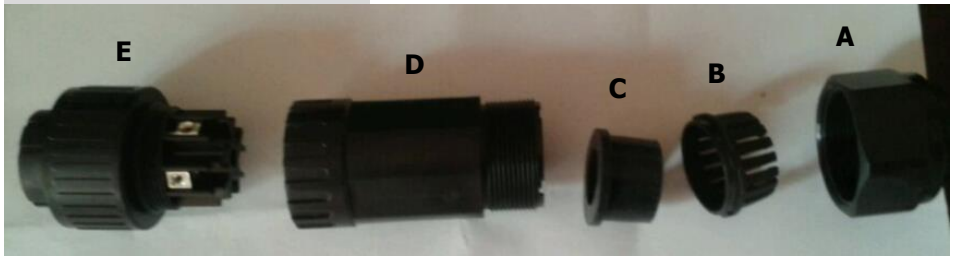
**WARNING!** It's very important for system safety and efficient operation to use appropriate cable for grid (utility) connection. To reduce risk of injury, please use the proper recommended cable size as below.

Suggested cable requirement for AC wire:

Nominal Grid Voltage	230VAC per phase
Conductor cross-section (mm <sup>2</sup> )	9-10
AWG no.	8

### 5-2. Connecting to the AC Utility

Overview of AC Connection Socket



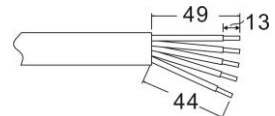
Component	Description
A	Pressure dome
B	Clip
C	Sealing nut
D	Protective element
E	Socket element

Step 1: Check the grid voltage and frequency with an AC voltmeter. It should be the same to "VAC" value on the product label.

Step 2: Turn off the circuit breaker.

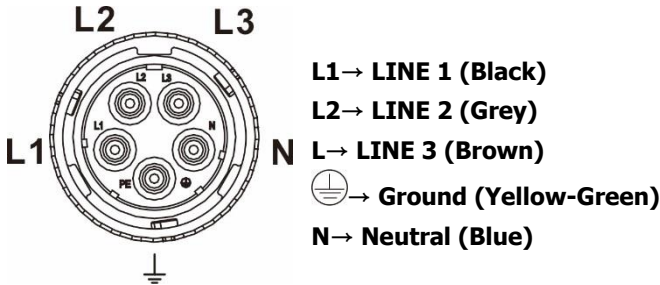
Step 3: Remove insulation sleeve 13 mm for five conductors.

Step 4: Thread the five cables through pressure dome (A), clip (B), sealing nut (C) and protective element (D) in sequence.



Step 5: Thread five cables through socket element (E) according to polarities indicated on it and tighten the screws to fix wires after

connection.

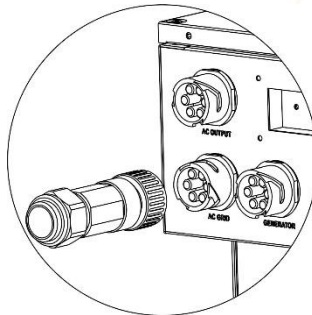


The reference tightening torque is 4-5 N.m.

Step 6: Push protective dome (D) on to socket element (E) until both are locked tightly. Then, twist protective element (D) and pressure dome (A) so that all cables are firmly connected.



Step 7: Plug the AC connection socket into AC INPUT terminal of the inverter.



**CAUTION:** To prevent risk of electric shock, ensure the ground wire is properly earthed before operating this hybrid inverter no matter the grid is connected or not.

## 6. Generator Connection

### 6-1. Preparation

**NOTE:** An additional disconnection device should be placed on in the building wiring installation.

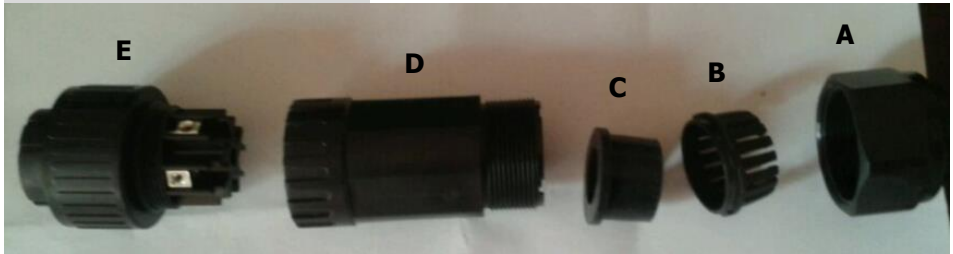
**WARNING!** It's very important for system safety and efficient operation to use appropriate cable for AC connection. To reduce risk of injury, please use the proper recommended cable size as below.

Suggested cable requirement for AC wire:

Nominal AC Voltage	230VAC per phase
Conductor cross-section (mm <sup>2</sup> )	9-10
AWG no.	8

### 6-2. Connecting to the Generator input

Overview of AC Connection Socket



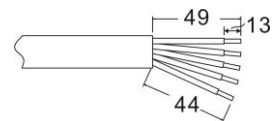
Component	Description
A	Pressure dome
B	Clip
C	Sealing nut
D	Protective element
E	Socket element

Step 1: Check the grid voltage and frequency with an AC voltmeter. It should be the same to "VAC" value on the product label.

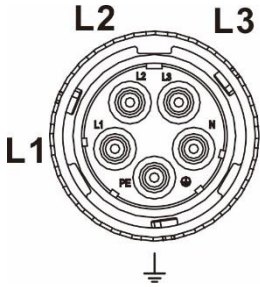
Step 2: Turn off the circuit breaker.

Step 3: Remove insulation sleeve 13 mm for five conductors.

Step 4: Thread the five cables through pressure dome (A), clip (B), sealing nut (C) and protective element (D) in sequence.



Step 5: Thread five cables through socket element (E) according to polarities indicated on it and tighten the screws to fix wires after connection.



**L1** → LINE 1 (Black)

**L2** → LINE 2 (Grey)

**L3** → LINE 3 (Brown)

**PE** → Ground (Yellow-Green)

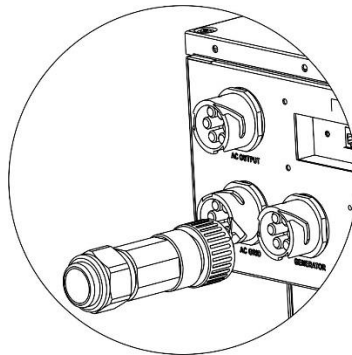
**N** → Neutral (Blue)

The reference tightening torque is 4-5 N.m.

Step 6: Push protective dome (D) on to socket element (E) until both are locked tightly. Then, twist protective element (D) and pressure dome (A) so that all cables are firmly connected.



Step 7: Plug the Generator connection socket into GENERATOR terminal of the inverter.



**CAUTION:** To prevent risk of electric shock, ensure the ground wire is properly earthed before operating this hybrid inverter no matter the grid is connected or not.

## 7. PV Module (DC) Connection

**NOTE1:** The overvoltage category of the PV input is II.

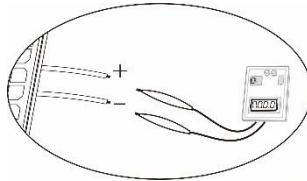
**NOTE2:** Please use 1000VDC/35A circuit breaker.

Please follow below steps to implement PV module connection:

**WARNING:** Because this inverter is non-isolated, only two types of PV modules are acceptable: single crystalline and poly crystalline with class A-rated. To avoid any malfunction, do not connect any PV modules with possibility of leakage current to the inverter. For example, grounded PV modules will cause leakage current to the inverter.

**CAUTION:** It's requested to have PV junction box with surge protection. Otherwise, it will cause inverter damage when lightning occurs on PV modules.

Step 1: Check the input voltage of PV array modules. The acceptable input voltage of the inverter is 350VDC - 1000VDC. This system is only applied with three strings of PV array. Please make sure that the maximum current load of each PV input connector is 26A.







**CAUTION:** Exceeding the maximum input voltage can destroy the unit!! Check the system before wire connection.

Step 2: Disconnect the circuit breaker and switch off the DC switch.

Step 3: Assemble provided PV connectors with PV modules by the following below steps.

### **Components for PV connectors and Tools:**

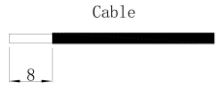
Female connector housing	
Female terminal	
Male connector housing	
Male terminal	

Crimping tool and spanner



**Cable preparation and connector assembly process:**

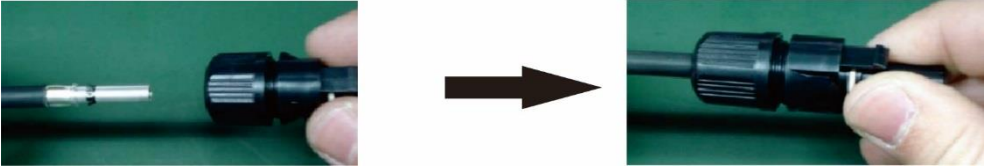
Strip two cables 8 mm on one side and be careful NOT to nick conductors.



Insert striped cable into female terminal and crimp female terminal as shown below charts.



Insert assembled cable into female connector housing as shown below charts.

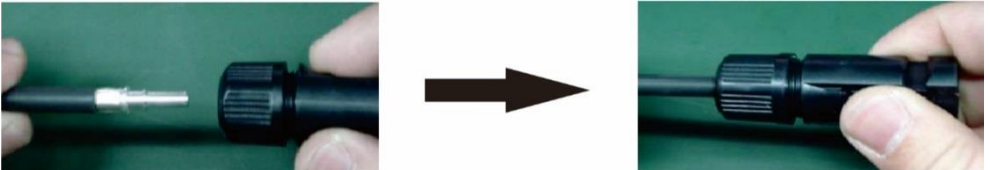


Reference insertion force:  $\leq 50N$   
Reference withdrawal force:  $\geq 50N$

Insert striped cable into male terminal and crimp male terminal as shown below charts.



Insert assembled cable into male connector housing as shown below charts.



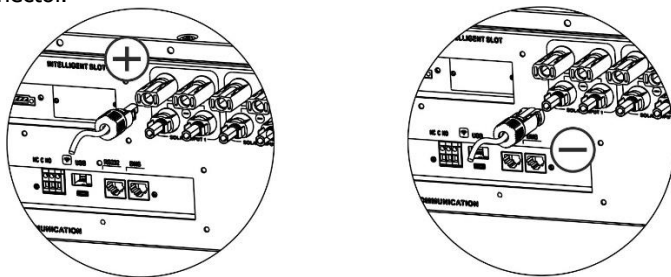
Reference insertion force:  $\leq 50N$   
Reference withdrawal force:  $\geq 50N$

Then, use spanner to screw pressure dome tightly to female connector and male connector as shown below.



The reference Nut cap locking force is 2.0~2.5Nm.

Step 4: Check correct polarity of connection cable from PV modules and PV input connectors. Then, connect positive pole (+) of connection cable to positive pole (+) of PV input connector. Connect negative pole (-) of connection cable to negative pole (-) of PV input connector.



**WARNING!** It's very important for system safety and efficient operation to use appropriate cable for PV module connection. To reduce risk of injury, please use the proper recommended cable size as below.

Nominal Grid Voltage	736VDC
Conductor cross-section (mm <sup>2</sup> )	6-8
AWG no.	10

**CAUTION: Never** directly touch terminals of the inverter. It will cause lethal electric

**CAUTION:** Do NOT touch the inverter to avoid electric shock. When PV modules are exposed to sunlight, it may generate DC voltage to the inverter.



## Recommended PV module Configuration

<b>PV Module Spec. (reference)</b>	<b>Total input power</b>	<b>Solar input 1</b>	<b>Solar input 2</b>	<b>Solar input 3</b>	<b>Q'ty of modules</b>
- 250Wp - Vmp: 36.7Vdc - Imp: 6.818A - Voc: 44Vdc - Isc: 7.636A - Cells: 60	3000W	12pieces in series	X	X	12pcs
	6000W	12pieces in series 2 strings in parallel	X	X	24pcs
	9000W	12pieces in series 2 strings in parallel	12pieces in series	X	36pcs
	12000W	12pieces in series 2 strings in parallel	12pieces in series 2 strings in parallel	X	48 pcs
	15000W	12pieces in series 2 strings in parallel	12pieces in series 2 strings in parallel	12pieces in series	60 pcs
	18000W	12pieces in series 2 strings in parallel	12pieces in series 2 strings in parallel	12pieces in series 2 strings in parallel	72 pcs
	21000W	14pieces in series 2 strings in parallel	14pieces in series 2 strings in parallel	14pieces in series 2 strings in parallel	84 pcs
	24000W	16pieces in series 2 strings in parallel	16pieces in series 2 strings in parallel	16pieces in series 2 strings in parallel	96 pcs
	27000W	18pieces in series 2 strings in parallel	18pieces in series 2 strings in parallel	18pieces in series 2 strings in parallel	108 pcs
	30000W	20pieces in series 2 strings in parallel	20pieces in series 2 strings in parallel	20pieces in series 2 strings in parallel	120 pcs

## 8. Battery Connection

**CAUTION:** Before connecting to batteries, please install separately a DC circuit breaker between inverter and batteries.

**NOTE1:** Please only use sealed lead acid battery, vented and Gel battery, lithium battery. Please check maximum charging voltage and current when first using this inverter. If using Lithium iron or Nicd battery, please consult with installer for the details.

**NOTE2:** Please use 1000VDC/100A circuit breaker.

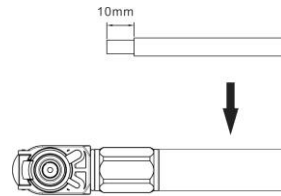
**NOTE3:** The overvoltage category of the battery input is II.

Please follow below steps to implement battery connection:

Step 1: Check the nominal voltage of batteries. The nominal input voltage for inverter is 736VDC.

Step 2: Turn off the circuit breaker.

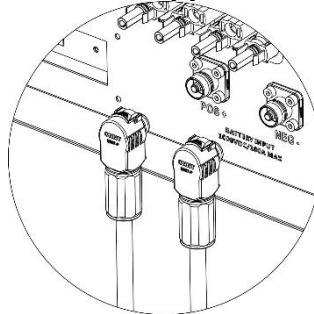
Step 3: Use two 4AWG battery cables. Remove insulation sleeve 10 mm and insert one end of conductor into ring terminal. Insert the other end of conductor into battery plug. Refer to right chart.



Step 4: Plug the assembled battery cables to battery terminals of the inverter.

**RED cable to the positive terminal (+);**

**BLACK cable to the negative terminal (-).**



**WARNING!** Wrong connections will damage the unit permanently.

## 9. Load (AC Output) Connection

### 8-1. Preparation

**CAUTION:** To prevent further supply to the load via the inverter during any mode of operation, an additional disconnection device should be placed on in the building wiring installation.

**WARNING!** It's very important for system safety and efficient operation to use appropriate cable for AC connection. To reduce risk of injury, please use the proper recommended cable size as below.

Nominal Grid Voltage	208/220/230/240 VAC per phase
Conductor cross-section (mm <sup>2</sup> )	5.5-10
AWG no.	8 AWG

### 8-2. Connecting to the AC output

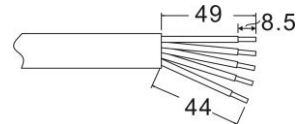
Overview of Load Connection Socket



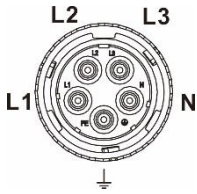
Component	Description
A	Pressure dome
B	Clip
C	Sealing nut
D	Protective element
E	Socket element


Step 1: Remove insulation sleeve 8.5 mm for five conductors.

Step 2: Thread the five cables through pressure dome (A), clip (B), sealing nut (C) and protective element (D) in sequence.



Step 3: Thread five cables through socket element (E) according to polarities indicated on it and tighten the screws to fix wires after connection.



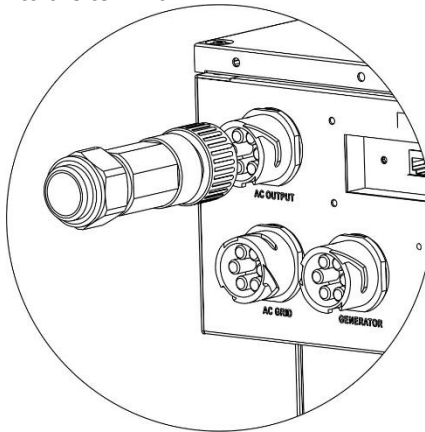
- L1** → **LINE 1 (Black)**
- L2** → **LINE 2 (Grey)**
- L3** → **LINE 3 (Brown)**
-  → **Ground (Yellow-Green)**
- N** → **Neutral (Blue)**

The reference tightening torque is 1.0-1.5 N.m.

Step 4: Push protective dome (D) on to socket element (E) until both are locked tightly. Then, twist protective element (D) and pressure dome (A) so that all cables are firmly connected.



Step 5: Plug the socket into the terminal.



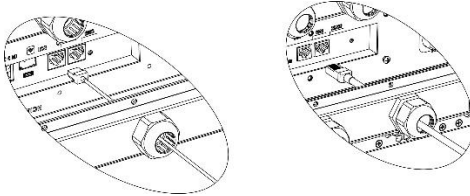
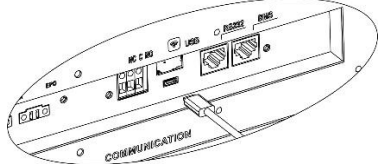
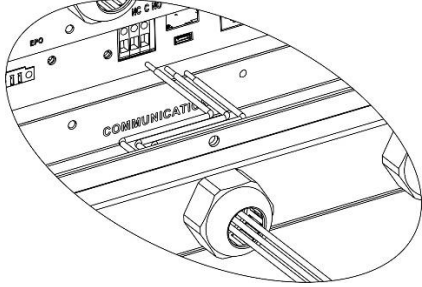
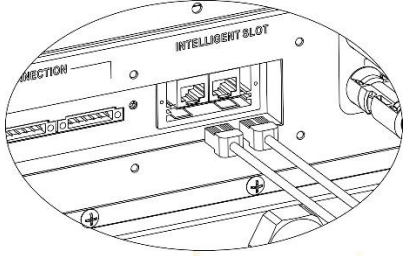
**CAUTION:** It's only allowed to connect load to "AC Output Connector". Do NOT connect the utility to "AC Output Connector".

**CAUTION:** Be sure to connect L terminal of load to L terminal of "AC Output Connector" and N terminal of load to N terminal of "AC Output Connector". The G terminal of "AC Output Connector" is connected to grounding of the load. Do NOT mis-connect.

## 9. Communication Connection

### Serial Connection

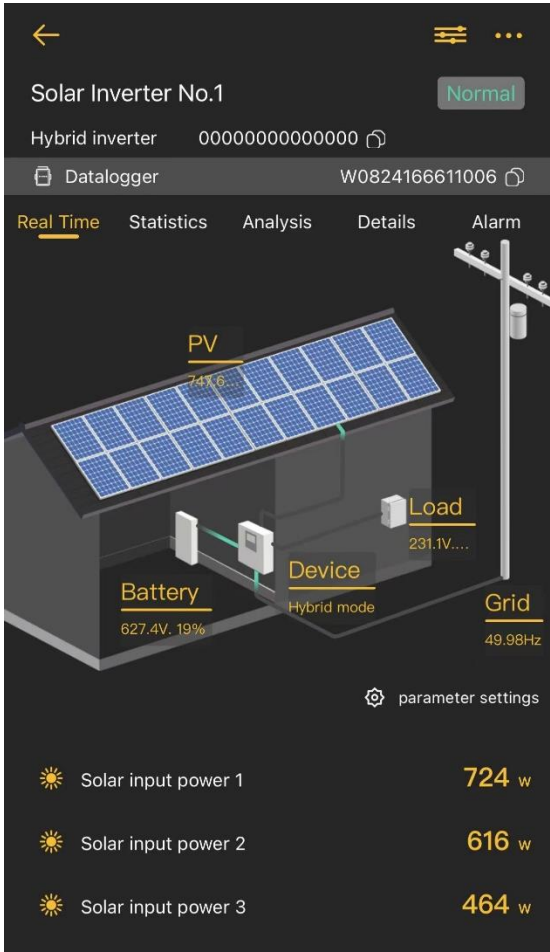
The inverter is equipped with several communication ports and it is also equipped with a slot for alternative communication interfaces in order to communicate with a PC with corresponding software. This intelligent slot is suitable to install with SNMP card and Modbus card. Follow below procedure to connect communication wiring and install the software.

<p>For RS232 or BMS port, use a RJ45 cable as follows:</p> 	<p>For USB port, use a USB cable as follows:</p> 
<p>For Dry contact port, please remove insulation sleeve 8 mm for three conductors and insert three cables into ports</p> 	<p>For SNMP or MODBUS Box, use the RJ45 cables as follows:</p> 

Please install monitoring software in your computer. Detailed information is listed in the chapter 12. After software is installed, you may initial the monitoring software and extract data through communication port.

### Wi-Fi Connection

Wi-Fi module can enable wireless communication between off-grid inverters and monitoring platform. Users have complete and remote monitoring and controlling experience for inverters when combining Wi-Fi module with Energy-Mate APP, available for both iOS and Android based device. All data loggers and parameters are saved in iCloud. For quick installation and operation, please refer to Appendix III - The Wi-Fi Operation Guide for details.



## 10. Dry Contact Signal


There is one dry contact available on the bottom panel. It could be used to remote control for external generator.

### 10-1. Electric Parameter

Parameter	Symbol	Max.	Unit
Relay DC voltage	Vdc	30	V
Relay DC current	Idc	1	A

Note: The application of the dry contact should not exceed the electric parameter shown as above. Otherwise, the internal relay will be damaged.

### 10-2. Function Description

Unit Status	Condition	Dry contact port: 	
		NO&C	NC&C
Power Off	Unit is off and no output is powered.	Open	Close
Power On	Battery voltage is lower than setting battery cut-off discharging voltage when grid is available.	Close	Open
	Battery voltage is lower than setting battery cut-off discharging voltage when grid is unavailable.	Close	Open
	Battery voltage is higher than below 2 setting values: 1. Battery re-discharging voltage when grid is available. 2. Battery re-discharging voltage when grid unavailable.	Open	Close

You can set the related parameters in bundled software, SolarPower. Refer to below chart:

Parameters setting

Min. PV input voltage:	<input type="text" value="300"/> V	<input type="button" value="Apply"/>	Battery cut-off discharging voltage when grid is available:	<input type="text" value="740"/> V	<input type="button" value="Apply"/>
Max. PV input voltage:	<input type="text" value="1,000"/> V	<input type="button" value="Apply"/>	Battery re-discharging voltage when Grid is available:	<input type="text" value="820"/> V	<input type="button" value="Apply"/>
Min. MPP voltage:	<input type="text" value="350"/> V	<input type="button" value="Apply"/>	Battery cut-off discharging voltage when grid is unavailable:	<input type="text" value="670"/> V	<input type="button" value="Apply"/>
Max. MPP voltage:	<input type="text" value="950"/> V	<input type="button" value="Apply"/>	Battery re-discharging voltage when Grid is unavailable:	<input type="text" value="680"/> V	<input type="button" value="Apply"/>
Max. charging current:	<input type="text" value="15"/> A	<input type="button" value="Apply"/>	Battery temperature compensation:	<input type="text" value="0"/> mV	<input type="button" value="Apply"/>
Max. AC charging current:	<input type="text" value="10"/> A	<input type="button" value="Apply"/>	Max. battery discharge current in hybrid mode:	<input type="text" value="100"/> A	<input type="button" value="Apply"/>
Bulk charging voltage(C.V. voltage):	<input type="text" value="825"/> V	<input type="button" value="Apply"/>	Feeding grid power calibration R:	<input type="text" value="0"/> W	<input type="button" value="Apply"/>
Floating charging voltage:	<input type="text" value="820"/> V	<input type="button" value="Apply"/>	Feeding grid power calibration S:	<input type="text" value="0"/> W	<input type="button" value="Apply"/>
Start LCD screen-saver after:	<input type="text" value="60"/> Sec.	<input type="button" value="Apply"/>	Feeding grid power calibration T:	<input type="text" value="0"/> W	<input type="button" value="Apply"/>

Mute buzzer alarm:	<input type="radio"/> Enable	<input checked="" type="radio"/> Disable	<input type="button" value="Apply"/>	Wide AC input range:	<input type="radio"/> Enable	<input checked="" type="radio"/> Disable	<input type="button" value="Apply"/>
Mute the buzzer in the Standby mode:	<input type="radio"/> Enable	<input checked="" type="radio"/> Disable	<input type="button" value="Apply"/>	Parallel for output:	<input type="radio"/> Enable	<input checked="" type="radio"/> Disable	<input type="button" value="Apply"/>
Mute alarm in battery mode:	<input type="radio"/> Enable	<input checked="" type="radio"/> Disable	<input type="button" value="Apply"/>	Output Neutral line grounding in battery mode:	<input checked="" type="radio"/> Enable	<input type="radio"/> Disable	<input type="button" value="Apply"/>
Activate Li-Fe battery while commissioning:	<input type="radio"/> Yes	<input checked="" type="radio"/> No	<input type="button" value="Apply"/>	BMS battery connect:	<input checked="" type="radio"/> Enable	<input type="radio"/> Disable	<input type="button" value="Apply"/>
Generator as AC source:	<input type="radio"/> Enable	<input checked="" type="radio"/> Disable	<input type="button" value="Apply"/>				

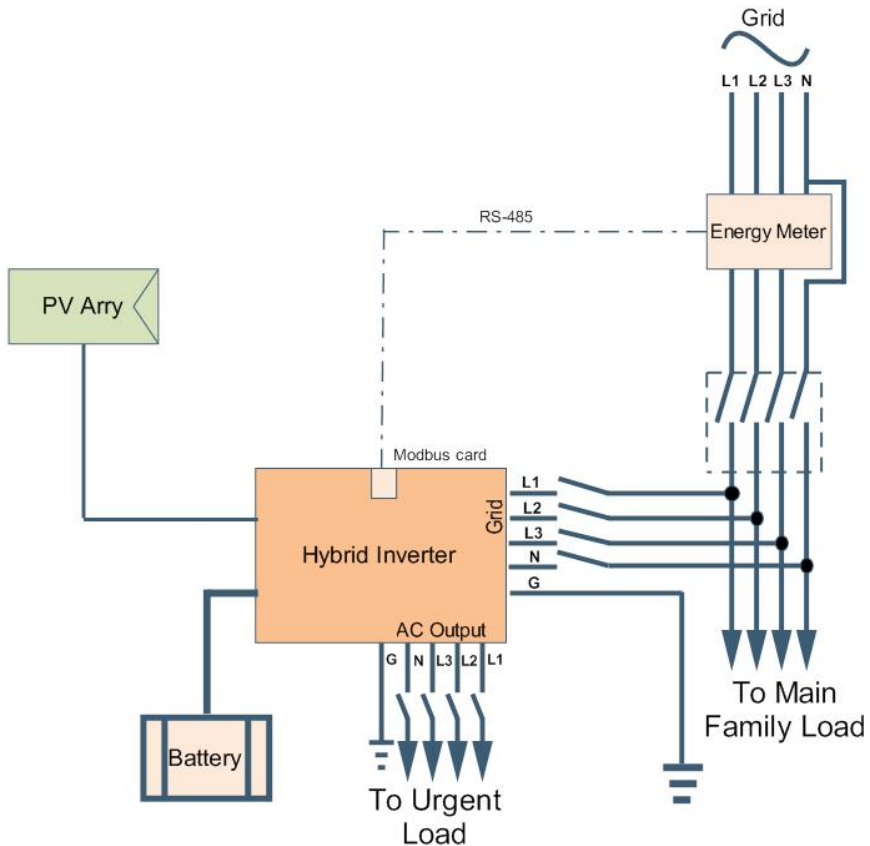


## 11. Application with Energy Meter

With Modbus card II and energy meter, hybrid inverter can be easily integrated into the existing household system. For details please refer to Modbus card II manual.

**Note:** this application is only valid for **Grid-Tie with Backup II** mode.

Equipped with Modbus card II, hybrid inverter is connected to energy meter with RS485 communication port. It's to arrange self-consumption via Modbus card to control power generation and battery charging of the inverter.



## 12. Commissioning

Step 1: Check the following requirements before commissioning:

- Ensure the inverter is firmly secured
- Check if the open circuit DC voltage of PV module meets requirement (Refer to Section 6)
- Check if the open circuit utility voltage of the utility is at approximately same to the nominal expected value from local utility company.
- Check if connection of AC cable to grid (utility) is correct if the utility is required.
- Full connection to PV modules.
- AC circuit breaker (only applied when the utility is required), battery circuit breaker, and DC circuit breaker are installed correctly.

Step 2: Switch on the battery circuit breaker and then switch on PV DC breaker. After that, if there is utility connection, please switch on the AC circuit breaker. At this moment, the inverter is turned on already. However, there is no output generation for loads. Then:

- If LCD lights up to display the current inverter status, commissioning has been successfully. After pressing "ON" button for 1 second when the utility is detected, this inverter will start to supply power to the loads. If no utility exists, simply press "ON" button for 3 seconds. Then, this inverter will start to supply power to the loads.
- If a warning/fault indicator appears in LCD, an error has occurred to this inverter. Please inform your installer.

Step 3: Please insert CD into your computer and install monitoring software in your PC. Follow below steps to install software.

1. Follow the on-screen instructions to install the software.
2. When your computer restarts, the monitoring software will appear as shortcut icon located in the system tray, near the clock.

**NOTE:** If using modbus card as communication interface, please install bundled software. Check local dealer for the details.

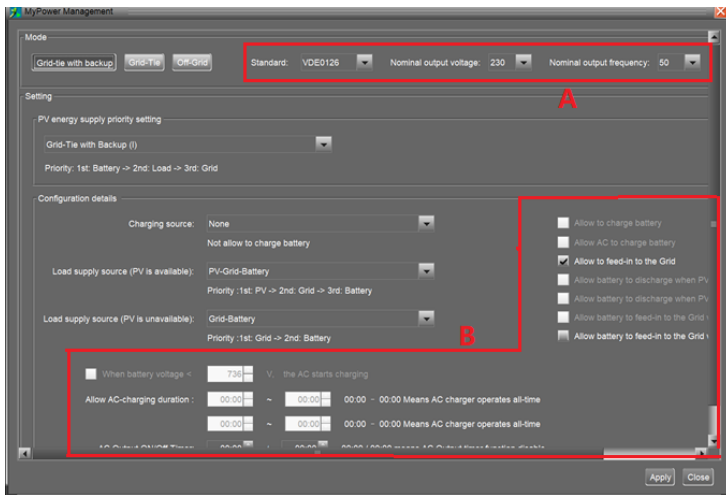
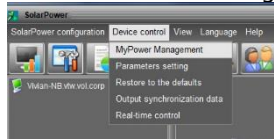
## 13. Initial Setup

Before inverter operation, it's required to set up "Operation Mode" via bundled software. Please strictly follow below steps to set up. For more details, please check software manual.

**Step 1:** After turning on the inverter and installing the software, please click "Open Monitor" to enter main screen of this software.

**Step 2:** Log in into software first by entering default password "administrator".

**Step 3:** Select Device Control>>MyPower Management. It is to set up inverter operation mode and personalized interface. Refer to diagram below.



### Mode

There are three operation modes: Grid-tie with backup, Grid-Tie and Off-Grid.

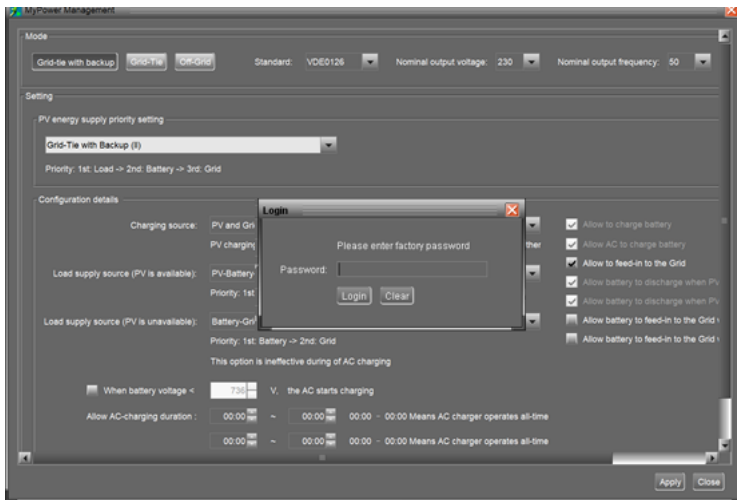
- Grid-tie with backup: PV power can feed-in back to grid, provide power to the load and charge battery. There are four options available in this mode: Grid-tie with backup I, II, III and IV. In this mode, users can configure PV power supply priority, charging source priority and load supply source priority. However, when Grid-tie with backup IV option is selected in PV energy supply priority, the inverter is only operated between two working logics based on defined peak time and off-peak time of electricity. Only peak time and off-peak time of electricity are able to set up for optimized electricity usage.

- Grid-Tie: PV power only can feed-in back to grid.
- Off-Grid: PV power only provides power to the load and charge battery. No feed-in back to grid is allowed.

### SECTION A:

Standard: It will list local grid standard. It's requested to have factory password to make any modifications. Please check local dealer only when this standard change is requested.

**CAUTION:** Wrong setting could cause the unit damage or not working.



Nominal Output Voltage: 230V.

Nominal Output Frequency: 50HZ.

### SECTION B:

This section contents may be different based on different selected types of operations.

Allow AC charging duration: It's a period time to allow AC (grid) to charge battery. When the duration is set up as 0:00-00:00, it means no time limitation for AC to charge battery.

AC output ON/Off Timer: Set up on/off time for AC output of inverter. If setting it as 00:00/00:00, this function is disabled.

Allow to charge battery: This option is automatically determined by setting in "Charging source". It's not allowed to modify here. When "NONE" is selected in charging source section, this option becomes unchecked as grey text.

Allow AC to charge battery: This option is automatically determined by setting in "Charging source". It's not allowed to modify here. When "Grid and PV" or "Grid or PV" is selected in charging source section, this option is default selected. Under Grid-tie mode, this option is invalid.

Allow to feed-in to the Grid: This option is only valid under Grid-tie and Grid-tie with backup modes. Users can decide if this inverter can feed-in to the grid.

Allow battery to discharge when PV is available: This option is automatically determined by setting in "Load supply source (PV is available)". When "Battery" is higher priority than "Grid" in Load supply source (PV is available), this option is default selected. Under Grid-tie, this option is invalid.

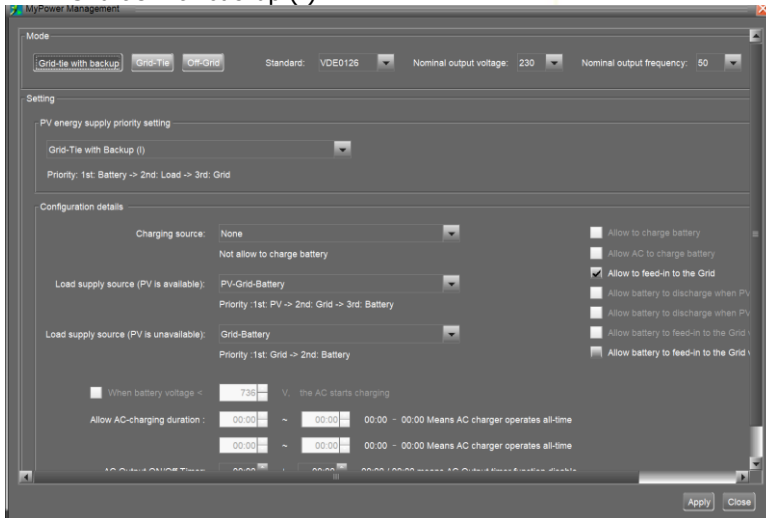
Allow battery to discharge when PV is unavailable: This option is automatically determined by setting in "Load supply source (PV is unavailable)". When "Battery" is higher priority than "Grid" in Load supply source (PV is unavailable), this option is default selected. Under Grid-tie mode, this option is invalid.

Allow battery to feed-in to the Grid when PV is available: This option is only valid in Grid-tie with backup II or Grid-tie with backup III modes.

Allow battery to feed-in to the Grid when PV is unavailable: This option is only valid in all options of Grid-tie with backup mode.

## Grid-tie with backup

### ● Grid-tie with backup (I) :



PV energy supply priority setting: 1<sup>st</sup> Battery, 2<sup>nd</sup> Load and 3<sup>rd</sup> Grid.

PV power will charge battery first, then provide power to the load. If there is any remaining power left, it will feed-in to the grid.

**Battery charging source:**

1. PV and Grid (Default)

It's allowed to charge battery from PV power first. If it's not sufficient, grid will charge battery.

2. PV only

It is only allow PV power to charge battery.

3. None

It is not allowed to charge battery no matter it's from PV power or grid.

**Load supply source:**

When PV power is available: 1<sup>st</sup> PV, 2<sup>nd</sup> Grid, 3<sup>rd</sup> Battery

If battery is not fully charged, PV power will charge battery first. And remaining PV power will provide power to the load. If it's not sufficient, grid will provide power to the load. If grid is not available at the same time, battery power will back up.

When PV power is not available:

1. 1<sup>st</sup> Grid, 2<sup>nd</sup> Battery (Default)

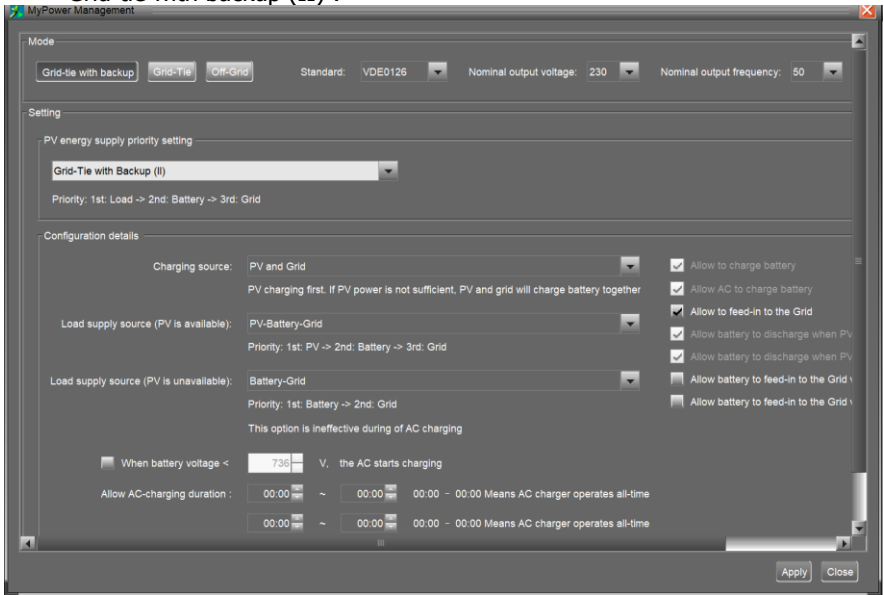
Grid will provide power to the load at first. If grid is not available, battery power will provide power backup.

2. 1<sup>st</sup> Battery, 2<sup>nd</sup> Grid

Battery power will provide power to the load at first. If battery power is running out, grid will back up the load.

**NOTE:** This option will become ineffective during AC charging time and the priority will automatically become 1<sup>st</sup> Grid and 2<sup>nd</sup> Battery order. Otherwise, it will cause battery damage.

## ● Grid-tie with backup (II) :



**PV energy supply priority setting:** 1<sup>st</sup> Load, 2<sup>nd</sup> Battery and 3<sup>rd</sup> Grid.

PV power will provide power to the load first. Then, it will charge battery. If there is any remaining power left, it will feed-in to the grid.

**Battery charging source:**

1. PV and Grid

It's allowed to charge battery from PV power first. If it's not sufficient, grid will charge battery.

2. PV only

It is only allow PV power to charge battery.

3. None

It is not allowed to charge battery no matter it's PV power or grid.

**Load supply source:**

When PV power is available:

1. 1<sup>st</sup> PV, 2<sup>nd</sup> Battery, 3<sup>rd</sup> Grid

PV power will provide power to the load first. If it's not sufficient, battery power will provide power to the load. When battery power is running out or not available, grid will back up the load.

2. 1<sup>st</sup> PV, 2<sup>nd</sup> Grid, 3<sup>rd</sup> Battery

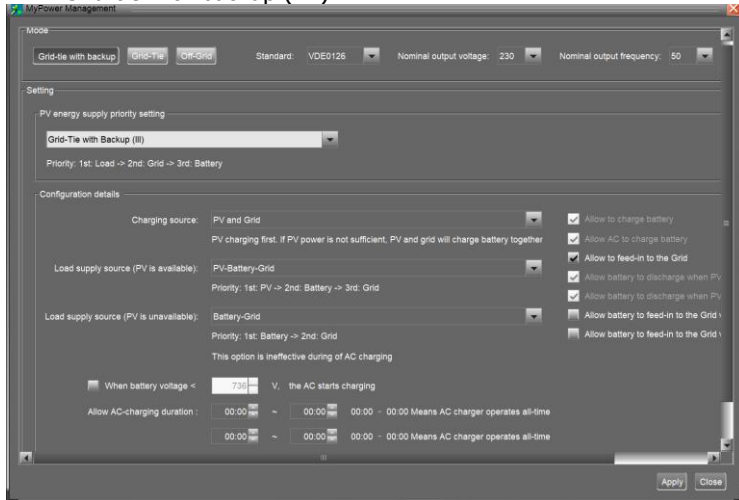
PV power will provide power to the load first. If it's not sufficient, grid will provide power to the load. If grid is not available at the same time, battery power will back up.

When PV power is not available:

1. 1<sup>st</sup> Grid, 2<sup>nd</sup> Battery: Grid will provide power to the load at first. If grid is not available, battery power will provide power backup.
2. 1<sup>st</sup> Battery, 2<sup>nd</sup> Grid: Battery power will provide power to the load at first. If battery power is running out, grid will back up the load

**NOTE:** This option will become ineffective during AC charging time and the priority will automatically become 1<sup>st</sup> Grid and 2<sup>nd</sup> Battery order. Otherwise, it will cause battery damage.

● **Grid-tie with backup (III):**



**PV energy supply priority setting:** 1<sup>st</sup> Load, 2<sup>nd</sup> Grid and 3<sup>rd</sup> Battery

PV power will provide power to the load first. If there is more PV power available, it will feed-in to the grid. If feed-in power reaches max. feed-in power setting, the remaining power will charge battery.

**NOTE:** The max. feed-in grid power setting is available in parameter setting. Please refer to software manual.

**Battery charging source:**

1. PV and Grid: It's allowed to charge battery from PV power first. If it's not sufficient, grid will charge battery.
2. PV only: It is only allow PV power to charge battery.
3. None: It is not allowed to charge battery no matter it's PV power or grid.

**Load supply source:**

When PV power is available:

1. 1<sup>st</sup> PV, 2<sup>nd</sup> Battery, 3<sup>rd</sup> Grid

PV power will provide power to the load first. If it's not sufficient, battery power will provide power to the load. When battery power is running out or not available, grid will back up the load.



## 2. 1<sup>st</sup> PV, 2<sup>nd</sup> Grid, 3<sup>rd</sup> Battery

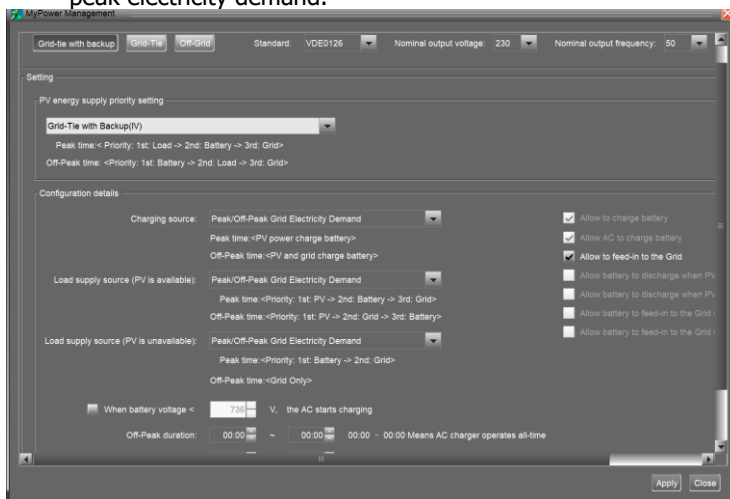
PV power will provide power to the load first. If it's not sufficient, grid will provide power to the load. If grid is not available at the same time, battery power will back up.

When PV power is not available:

1. 1<sup>st</sup> Grid, 2<sup>nd</sup> Battery: Grid will provide power to the load at first. If grid is not available, battery power will provide power backup.
2. 1<sup>st</sup> Battery, 2<sup>nd</sup> Grid: Battery power will provide power to the load at first. If battery power is running out, grid will back up the load.

**NOTE:** This option will become ineffective during AC charging time and the priority will automatically become 1<sup>st</sup> Grid and 2<sup>nd</sup> Battery order. Otherwise, it will cause battery damage.

- Grid-tie with backup (IV): Users are only allowed to set up peak time and off-peak electricity demand.



### Working logic under peak time:

**PV energy supply priority:** 1<sup>st</sup> Load, 2<sup>nd</sup> Battery and 3<sup>rd</sup> Grid

PV power will provide power to the load first. If PV power is sufficient, it will charge battery next. If there is remaining PV power left, it will feed-in to the grid. Feed-in to the grid is default disabled.

**Battery charging source:** PV only

Only after PV power fully supports the load, the remaining PV power is allowed to charge battery during peak time.

**Load supply source:** 1<sup>st</sup> PV, 2<sup>nd</sup> Battery, 3<sup>rd</sup> Grid

PV power will provide power to the load first. If PV power is not sufficient, battery power will back up the load. If battery power is not available, grid will provide the

load. When PV power is not available, battery power will supply the load first. If battery power is running out, grid will back up the load.

### Working logic under off-peak time:

PV energy supply priority: 1<sup>st</sup> Battery, 2<sup>nd</sup> Load and 3<sup>rd</sup> Grid

PV power will charge battery first. If PV power is sufficient, it will provide power to the loads. The remaining PV power will feed to the grid.

**NOTE:** The max. feed-in grid power setting is available in parameter setting. Please refer to software manual.

Battery charging source: PV and grid charge battery

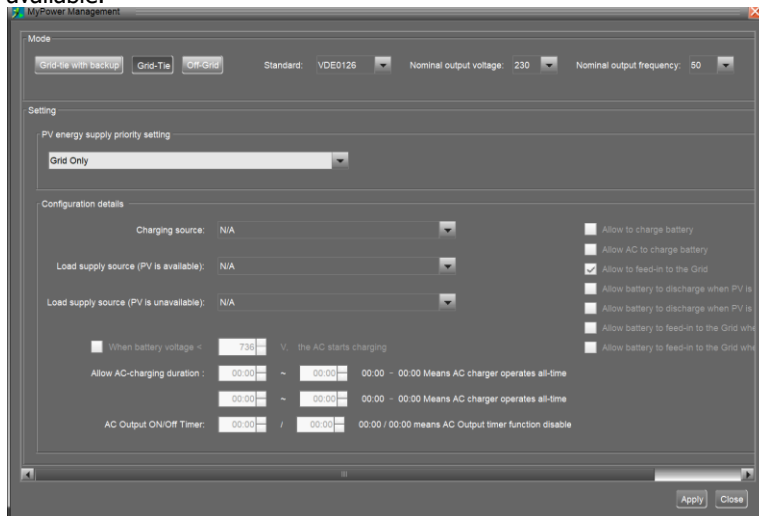
PV power will charge battery first during off-peak time. If it's not sufficient, grid will charge battery.

Load supply source: 1<sup>st</sup> PV, 2<sup>nd</sup> Grid, 3<sup>rd</sup> Battery

When battery is fully charged, remaining PV power will provide power to the load first. If PV power is not sufficient, grid will back up the load. If grid power is not available, battery power will provide power to the load.

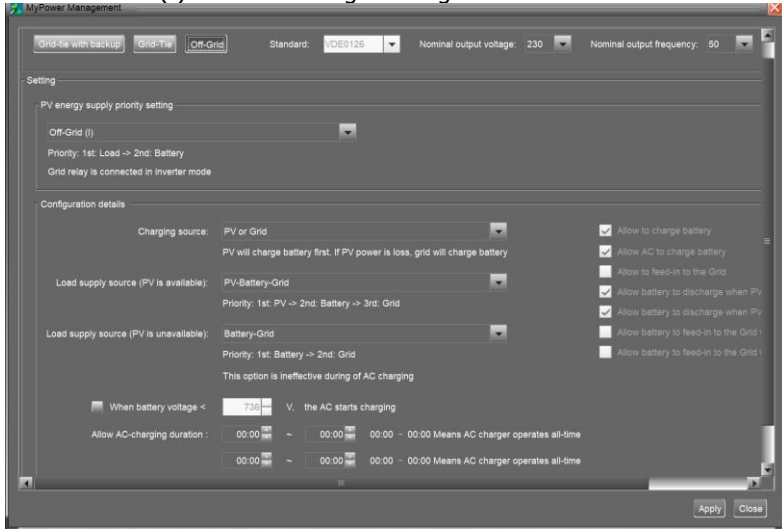
### Grid-Tie

Under this operation mode, PV power only feeds-in to the grid. No priority setting is available.



## Off-Grid

### ● Off-Grid (I): Default setting for off-grid mode.



#### **PV energy supply priority setting: 1<sup>st</sup> Load, 2<sup>nd</sup> Battery**

PV power will provide power to the load first and then charge battery. Feed-in to the grid is not allowed under this mode. At the same time, the grid relay is connected in Inverter mode. That means the transfer time from inverter mode to battery mode will be less than 15ms. Besides, it will avoid overload fault because grid can supply load when connected load is over 30KW.

#### **Battery charging source:**

1. PV or Grid: If there is remaining PV power after supporting the loads, it will charge battery first. Only until PV power is not available, grid will charge battery. (Default)
2. PV only: It is only allow PV power to charge battery.
3. None: It is not allowed to charge battery no matter it's PV power or grid.

#### **Load supply source:**

When PV power is available:

1. 1<sup>st</sup> PV, 2<sup>nd</sup> Battery, 3<sup>rd</sup> Grid (Default)

PV power will provide power to the load first. If it's not sufficient, battery power will provide power to the load. When battery power is running out or not available, grid will back up the load.

2. 1<sup>st</sup> PV, 2<sup>nd</sup> Grid, 3<sup>rd</sup> Battery

PV power will provide power to the load first. If it's not sufficient, grid will provide power to the load. If grid is not available at the same time, battery power will back up.

When PV power is not available:

1. 1<sup>st</sup> Grid, 2<sup>nd</sup> Battery

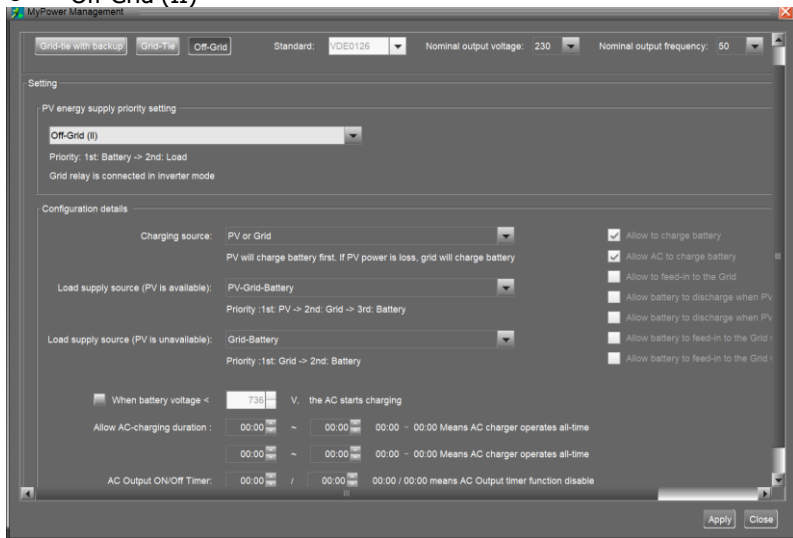
Grid will provide power to the load at first. If grid is not available, battery power will provide power backup.

## 2. 1<sup>st</sup> Battery, 2<sup>nd</sup> Grid (Default)

Battery power will provide power to the load at first. If battery power is running out, grid will back up the load.

**NOTE:** This option will become ineffective during AC charging time and the priority will automatically become 1<sup>st</sup> Grid and 2<sup>nd</sup> Battery order. Otherwise, it will cause battery damage.

## ● Off-Grid (II)



**PV energy supply priority setting:** 1<sup>st</sup> Battery, 2<sup>nd</sup> Load

PV power will charge battery first. After battery is fully charged, if there is remaining PV power left, it will provide power to the load. Feed-in to the grid is not allowed under this mode. At the same time, the grid relay is connected in Inverter mode. That means the transfer time from inverter mode to battery mode will be less than 15ms. Besides, it will avoid overload fault because grid can supply load when connected load is over 30KW.

**Battery charging source:**

1. PV or Grid: If there is remaining PV power after supporting the loads, it will charge battery first. Only until PV power is not available, grid will charge battery.
2. PV only: It is only allow PV power to charge battery.
3. None: It is not allowed to charge battery no matter it's PV power or grid.

**NOTE:** It's allowed to set up AC charging duration.

**Load supply source:**

When PV power is available: 1<sup>st</sup> PV, 2<sup>nd</sup> Grid, 3<sup>rd</sup> Battery

PV power will provide power to the load first. If it's not sufficient, grid will provide

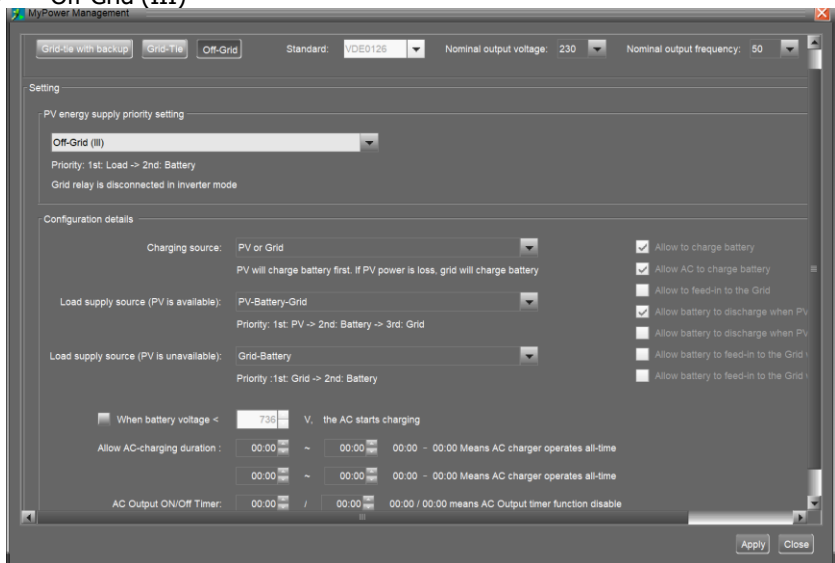
power to the load. If grid is not available at the same time, battery power will back up.

When PV power is not available:

1. 1<sup>st</sup> Grid, 2<sup>nd</sup> Battery: Grid will provide power to the load at first. If grid is not available, battery power will provide power backup.
2. 1<sup>st</sup> Battery, 2<sup>nd</sup> Grid: Battery power will provide power to the load at first. If battery power is running out, grid will back up the load.

**NOTE:** This option will become ineffective during AC charging time and the priority will automatically become 1<sup>st</sup> Grid and 2<sup>nd</sup> Battery order. Otherwise, it will cause battery damage.

### ● Off-Grid (III)



**PV energy supply priority setting:** 1<sup>st</sup> Load, 2<sup>nd</sup> Battery

PV power will provide power to load first and then charge battery. Feed-in to the grid is not allowed under this mode. The grid relay is NOT connected in Inverter mode. That means the transfer time from inverter mode to battery mode will be about 15ms. If connected load is over 30KW and grid is available, this inverter will allow grid to provide power to the loads and PV power to charge battery. Otherwise, this inverter will activate fault protection.

**Battery charging source:**

1. PV or Grid: If there is remaining PV power after supporting the loads, it will charge battery first. Only until PV power is not available, grid will charge battery.
2. PV only: It is only allow PV power to charge battery.
3. None: It is not allowed to charge battery no matter it's PV power or grid.

**NOTE:** It's allowed to set up AC charging duration.

**Load supply source:**

When PV power is available: 1<sup>st</sup> PV, 2<sup>nd</sup> Battery, 3<sup>rd</sup> Grid

PV power will provide power to the load first. If it's not sufficient, battery power will back up the load. Only after battery power is running, Grid will back up the load.

When PV power is not available:

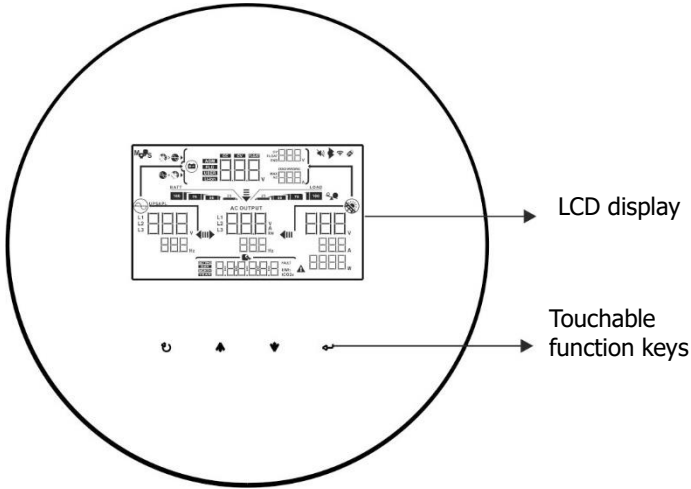
1. 1<sup>st</sup> Grid, 2<sup>nd</sup> Battery: Grid will provide power to the load at first. If grid is not available, battery power will provide power backup.
2. 1<sup>st</sup> Battery, 2<sup>nd</sup> Grid: Battery power will provide power to the load at first. If battery power is running out, grid will back up the load.

**NOTE:** This option will become ineffective during AC charging time and the priority will automatically become 1<sup>st</sup> Grid and 2<sup>nd</sup> Battery order. Otherwise, it will cause battery damage.

# 14. Operation

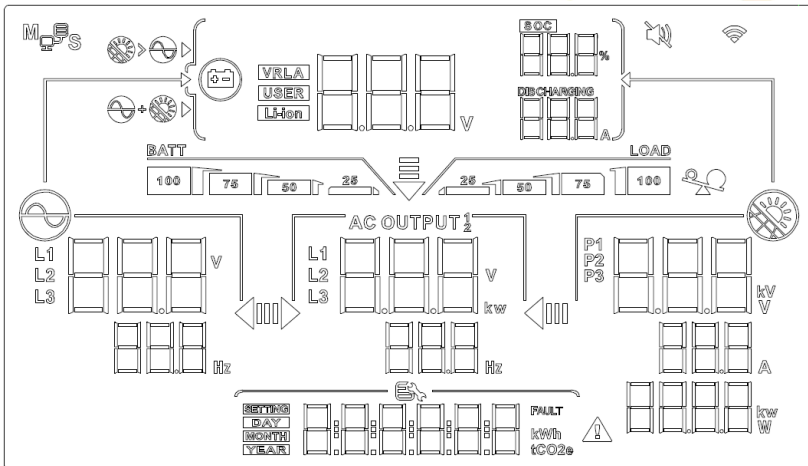
## 14-1. Interface

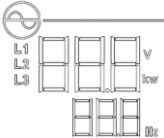
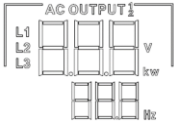
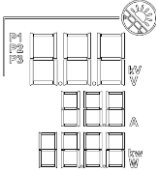


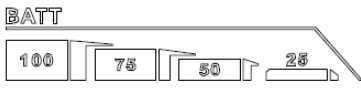


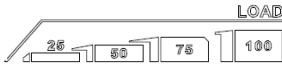


The operation LCD panel, shown in the chart below, includes four touchable function keys and a LCD display to indicate the operating status and input/output power information.





**NOTICE:** To accurately monitor and calculate the energy generation, please calibrate the timer of this unit via software every one month. For the detailed calibration, please check the user manual of bundled software.

## 14-2. LCD Information Define



Display	Function
 <p>The display shows a circle with a diagonal slash (no AC) icon, three line phase indicators (L1, L2, L3), and two rows of three-digit numbers. The top row is labeled 'V' and 'Hz', and the bottom row is labeled 'Hz'.</p>	<p>Indicates AC input voltage and frequency.  V: voltage, Hz: frequency,  L1/L2/L3: Line phase</p>
 <p>The display shows 'AC OUTPUT' with a lightning bolt icon, three line phase indicators (L1, L2, L3), and two rows of three-digit numbers. The top row is labeled 'V' and 'kw', and the bottom row is labeled 'Hz'.</p>	<p>Indicates AC output power, voltage, and frequency.  KW: active power, V: Voltage,  Hz: frequency,  L1/L2/L3: AC output phase</p>
 <p>The display shows a lightning bolt icon with a circle and slash, three PV input indicators (P1, P2, P3), and two rows of three-digit numbers. The top row is labeled 'kW' and 'V', and the bottom row is labeled 'kW' and 'A'.</p>	<p>Indicates PV input voltage or power.  KV/V: voltage, KW: power,  P1: PV input 1,  P2: PV input 2,  P3: PV input 3</p>
 <p>The display shows a battery icon with a plus/minus sign, a 'Li-ion' label, a three-digit number, a 'V' label, a percentage icon, and a 'DISCHARGE' label with a three-digit number and an 'A' label.</p>	<p>Indicates battery voltage ,percentage and battery status  Indicates charging current to battery or discharging current from battery.  V: Battery voltage %: percentage,  A: Battery current  Li-ion: Lithium battery communication connection</p>
 <p>The display shows a grid for date and time, a 'FAULT' warning icon, and labels for 'kW/h' and 'kWh'.</p>	<p>Indicates date and time or the date and time users set for querying energy generation.</p>
 <p>The display shows a battery level bar with segments labeled '100', '75', '50', and '25'. A '25' icon is shown flashing.</p>	<p>Indicates battery level by 0-24%, 25-49%, 50-74% and 75-100% and charging status.  Icon  flashing indicates the battery voltage is too low.</p>
 <p>The display shows a speaker with a slash through it (silent buzzer) and a WiFi signal icon.</p>	<p>Indicates the buzzer is silent and WiFi is connected.</p>
 <p>The display shows a load bar with segments labeled '25', '50', '75', and '100'.</p>	<p>Indicates load. If the icons of 25, 50, 75 and 100 are not displayed, indicates AC output for loads is enabled but there is no power provided from inverter.</p>
 <p>The display shows a scale icon with a weight on one side, indicating overload.</p>	<p>Indicates overload.</p>
 <p>The display shows 'M' and 'S' with a double-headed arrow between them, indicating parallel operation.</p>	<p>Indicates parallel operation is working.  M: Master, S: Slave</p>



	Allow AC and PV power to charge.
	Only PV energy is allowed to charge.


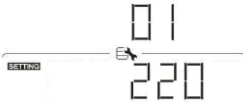
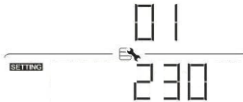


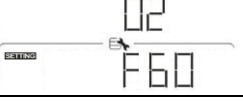
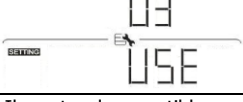
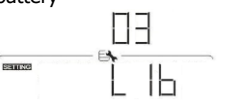
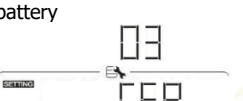
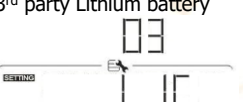

### 14-3. Button Definition

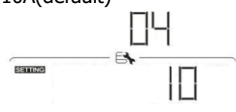
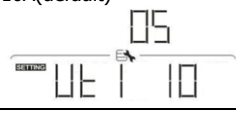
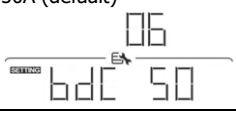
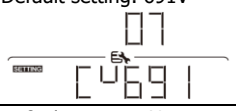
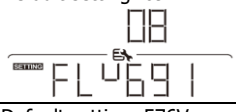
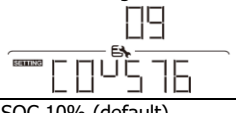


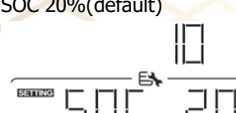
Button	Operation	Function
ENTER	Short press.	Enter query menu. If it's in query menu, press this button to confirm selection or entry.
		Press and hold the button for approximately 1 second until the load icon is illuminated. This inverter is able to provide power to connected loads via AC output connector.
ESC	Short press.	Return to previous menu.
	Press and hold the button until the load icon disappears.	Turn off power to the loads.
Up	Short press.	Select last selection or increase value.
Down	Short press.	If it's in query menu, press this button to jump to next selection or decrease value.
Up+Down	Press and hold these two button for two seconds	Enter setting mode.

**NOTE:** If backlight shuts off, you may activate it by pressing any button.

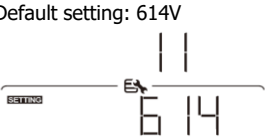
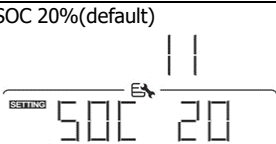
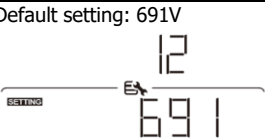
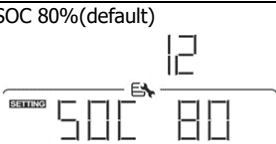
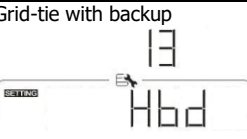
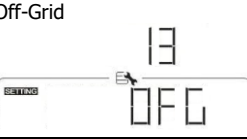
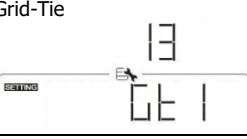
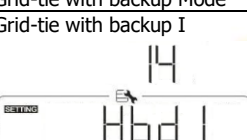
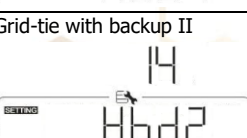
## 14-4. LCD Setting


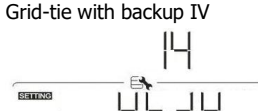


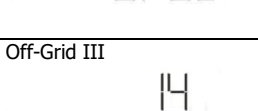
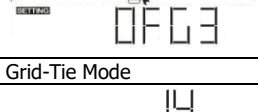
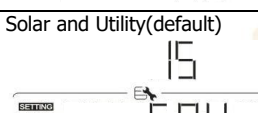
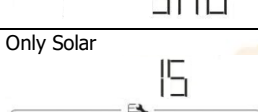

After touching and holding "UP" and "DOWN" buttons for 2 seconds, the unit will enter setting mode. Press "UP" or "DOWN" button to select setting programs. And then, press "ENTER" button to confirm the selection or "ESC" button to exit.



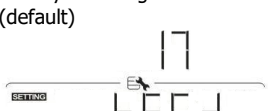
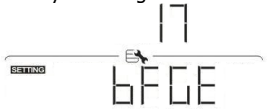


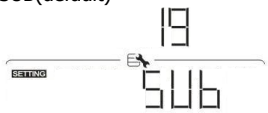
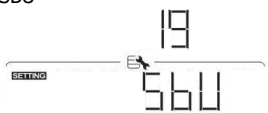
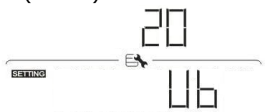
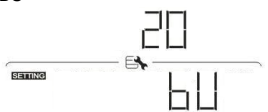

Program	Description	Selectable option	
00	Exit setting mode	Escape 	
01	Output voltage	220Vac 	230Vac(default) 
		240V 	
02	Output frequency	50HZ(default) 	60HZ 
03	Battery type	User-Defined(default) 	If "User Defined" is selected, battery charge voltage and low DC cut off voltage can be set up in program 4 , 7, 8 and 9.
		LIb-protocol compatible battery 	Select "LIb" if using Lithium battery compatible to Lib protocol. If selected, programs of 4, 7, 8 and 9 will be automatically set up. No need for further setting.
		REP-protocol compatible battery 	Select "REP" if using Lithium battery compatible to REP protocol. If selected, programs of 4, 7, 8 and 9 will be automatically set up. No need for further setting.
		3 <sup>rd</sup> party Lithium battery 	If selected, programs of 4, 7, 8 and 9 will be automatically set up. No need for further setting. Please contact the battery supplier for installation procedure.
		VSC 	If selected, standard CAN communication will be supported.

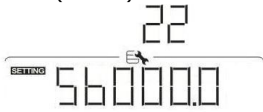

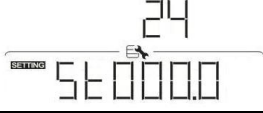
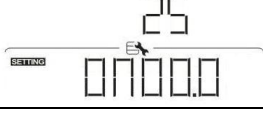

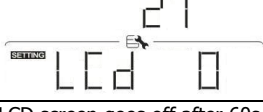
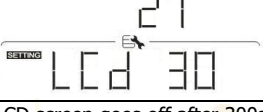
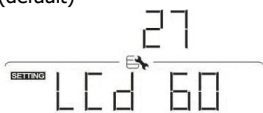


04	Maximum charging current: To configure total charging current for solar and utility chargers. (Max. charging current = utility charging current + solar charging current)	10A(default) 	Setting range is from 1A to 50A.Increment of each click is 1A.
05	Maximum utility charging current	10A(default) 	Setting range is from 1A to 50A.Increment of each click is 1A.
06	Maximum discharging current	50A (default) 	Setting range is from 1A to 50A.Increment of each click is 1A.
07	Bulk charging voltage (C.V voltage)	Default setting: 691V 	Setting range is from 600V to 950V. Increment of each click is 1V.
08	Floating charging voltage	Default setting: 691V 	Setting range is from 600V to 950V. Increment of each click is 1V.
09	Low DC cut off battery voltage or SOC percentage setting when grid is unavailable	Default setting: 576V 	Setting range is from 576V to 800V. Increment of each click is 1V.
		SOC 10% (default) 	If any lithium battery is selected in program 03, setting value will change to SOC automatically. Setting range is from 5% to 80%. Increment of each click is 5%.
10	Battery re-discharging voltage or SOC percentage when grid is unavailable.	Default setting: 614V 	Setting range is form 576V to 800V. Increment of each click is 1V.
		SOC 20%(default) 	If any lithium battery is selected in program 03, setting value will change to SOC automatically. Setting range is from 10% to 100%. Increment of each click is 5%.



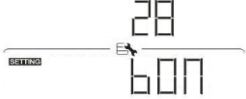
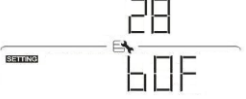

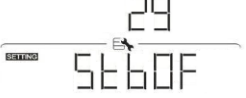
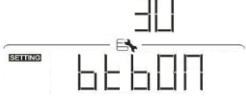

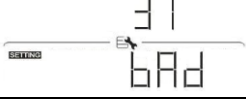

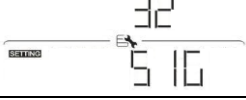
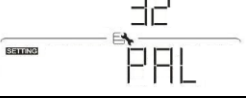
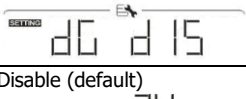

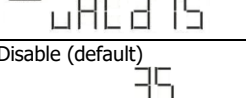

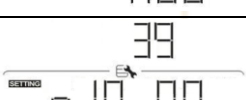
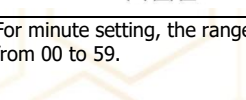


11	Low DC cut off battery voltage or SOC percentage when grid is available.	Default setting: 614V 	Setting range is from 576V to 900V voltage. Increment of each click is 1V
		SOC 20%(default) 	If any lithium battery is selected in program 03, setting value will change to SOC automatically. Setting range is from 5% to 95%. Increment of each click is 5%.
12	Battery re-discharging voltage or SOC percentage when grid is available	Default setting: 691V 	Setting range is from 576V to 900V voltage. Increment of each click is 1V
		SOC 80%(default) 	If any lithium battery is selected in program 03, setting value will change to SOC automatically. Setting range is from 10% to 100%. Increment of each click is 5%.
13	Work Mode	Grid-tie with backup 	PV power can feed-in back to grid, provide power to the load and charge battery.
		Off-Grid 	PV power only provides power to the load and charge battery. No feed-in back to grid is allowed.
		Grid-Tie 	PV power only can feed-in back to grid.
14	PV energy supply priority setting	Grid-tie with backup Mode Grid-tie with backup I 	Battery-Load-Grid: PV power will charge battery first, then provide power to the load. If there is any remaining power left, it will feed-in to the grid.
		Grid-tie with backup II 	Load-Battery-Grid: PV power will provide power to the load first. Then, it will charge battery. If there is any remaining power left, it will feed-in to the grid.

14	PV energy supply priority setting	Grid-tie with backup Mode Grid-tie with backup III 	Load-Grid-Battery: PV power will provide power to the load first. If there is more PV power available, it will feed-in to the grid. If feed-in power reaches max. feed-in power setting, the remaining power will charge battery.
		Grid-tie with backup IV 	I selected, users are only allowed to set up peak time and off-peak electricity demand. Programs of 15, 17, 18, 19 and 20 can't be set and peak/off-peak time can be set in programs of 21, 22, 23 and 24.
14	PV energy supply priority setting	Off-Grid Mode Off-Grid I 	Load-Battery: PV power will provide power to the load first and then charge battery. Feed-in to the grid is not allowed under this mode. At the same time, the grid relay is connected in Inverter mode.
		Off-Grid II 	Battery-Load: PV power will charge battery first. After battery is fully charged, if there is remaining PV power left, it will provide power to the load. Feed-in to the grid is not allowed under this mode. At the same time, the grid relay is connected in Inverter mode.
		Off-Grid III 	Load-Battery: PV power will provide power to load first and then charge battery. Feed-in to the grid is not allowed under this mode. The grid relay is NOT connected in Inverter mode.
		Grid-Tie Mode 	PV power only feeds-in to the grid. No priority setting is available.
15	Charger source priority	Solar and Utility(default) 	If there is remaining PV power after supporting the loads, it will charge battery first. Only until PV power is not available, grid will charge battery.
		Only Solar 	It is only allow PV power to charge battery.
		None 	It is not allowed to charge battery no matter it's PV power or grid.

16	Feed to grid configuration	Feed to grid disable (default) 	Feed to grid enable 
17	Battery energy feed to grid configuration when solar is available	Battery feed to grid disable (default) 	Battery feed to grid enable 
18	Battery energy feed to grid configuration when solar is unavailable	Battery feed to grid disable (default) 	Feed to grid enable 
19	Load supply source when PV is available.	SUB(default) 	Solar-grid-battery: PV power will provide power to the load first. If it's not sufficient, grid will provide power to the load. If grid is not available at the same time, battery power will back up.
		SBU 	Solar-Battery-Grid: PV power will provide power to the load first. If it's not sufficient, battery power will provide power to the load. When battery power is running out or not available, grid will back up the load.
20	Load supply source when PV is unavailable.	UB(default) 	Grid-Battery: Grid will provide power to the load at first. If grid is not available, battery power will provide power backup.
		BU 	Battery-Grid: Battery power will provide power to the load at first. If battery power is running out, grid will back up the load. This setting is ineffective during AC charging.
21	Start charging time for first AC charging interval	00:00 (Default) 	The setting range of first start charging time for AC charger is from 00:00 to 23:00. Increment of each click is 1 hour.

22	Stop charging time for first AC charging interval	00:00 (Default) 	The setting range of first stop charging time for AC charger is from 00:00 to 23:00. Increment of each click is 1 hour.
23	Start charging time for second AC charging interval	00:00 (Default) 	The setting range of second start charging time for AC charger is from 00:00 to 23:00. Increment of each click is 1 hour.
24	Stop charging time for second AC charging interval	00:00 (Default) 	The setting range of second stop charging time for AC charger is from 00:00 to 23:00. Increment of each click is 1 hour.
25	Scheduled time for AC output on	00:00 (Default) 	The setting range of scheduled time for AC output on is from 00:00 to 23:00. Increment of each click is 1 hour.
26	Scheduled time for AC output off	00:00 (Default) 	The setting range of scheduled time for AC output off is from 00:00 to 23:00. Increment of each click is 1 hour.
27	Waiting time for LCD display off	LCD screen is always on 	LCD screen goes off after 30s 
		LCD screen goes off after 60s (default) 	LCD screen goes off after 300s. 
		LCD screen goes off after 600s 	



28	Alarm control	Alarm on (default) 	Alarm off 
29	Alarm control in standby mode	Alarm on in standby mode (default) 	Alarm off in standby mode 
30	Alarm control in battery mode	Alarm on in battery mode (default) 	Alarm off in battery mode 
31	Activate lithium battery when the device is powered on	Activate lithium battery enable (default) 	Activate lithium battery disable 
32	AC output mode	Single: This inverter is used in single phase application (default) 	Parallel: This inverter is operated in parallel system. 
33	Generator as AC source	Disable (default) 	Enable 
34	Wide AC input range	Disable (default) 	Enable 
35	N/G relay close in battery mode	Disable (default) 	Enable 
39	Time setting – Minute		For minute setting, the range is from 00 to 59.
40	Time setting –Hour		For hour setting, the range is from 00 to 23.

41	Time setting–Day		For day setting, the range is from 00 to 31.
42	Time setting–Month		For month setting, the range is from 01 to 12.
43	Time setting –Year		For year setting, the range is from 17 to 99.
60	Low DC cut off voltage or SOC percentage on second AC (L2) output.	Default setting:576V 	Setting range is from 576V to 800V. Increment of each click is 0.1V.
		SOC 10%(default) 	If any lithium battery is selected in program 03, setting value will change to SOC automatically. Setting range is from 5% to 100%. Increment of each click is 5%.
61	Setting discharge time on the second AC (L2) output	Disable(default) 	Setting range is disable and then from 5 min to 990 min.
62	Scheduled time for the second AC (L2) output on	00:00 (Default) 	The setting range of AC output on is from 00:00 to 23:00. Increment of each click is 1 hour.
63	Scheduled time for the second AC (L2) output off	00:00 (Default) 	The setting range of AC output off is from 00:00 to 23:00. Increment of each click is 1 hour.
64	Battery re-discharging voltage or SOC percentage on the second AC (L2) output	Default setting:614V 	Setting range is from 576V to 800V. Increment of each click is 0.1V.
		SOC 20%(default) 	If any lithium battery is selected in program 03, setting value will change to SOC automatically. Setting range is from 10% to 100%. Increment of each click is 5%.

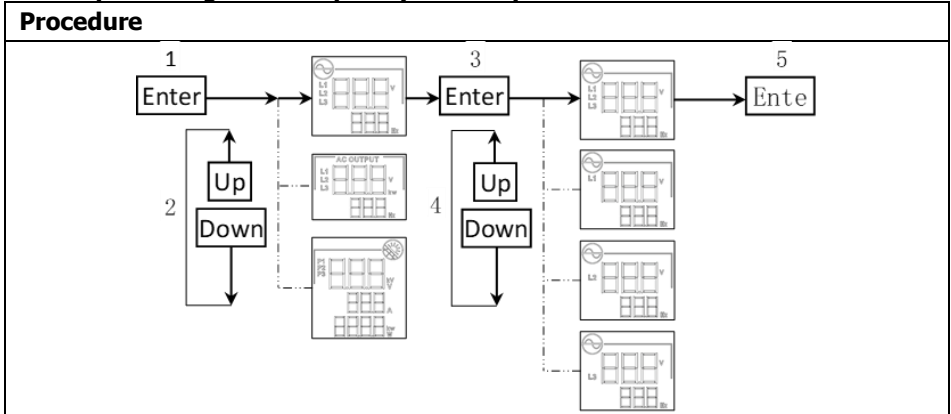
## 14-5. Query Menu Operation

The display shows current contents that have been set. The displayed contents can be changed in query menu via button operation. Press 'Enter' button to enter query menu. There are three query selections:

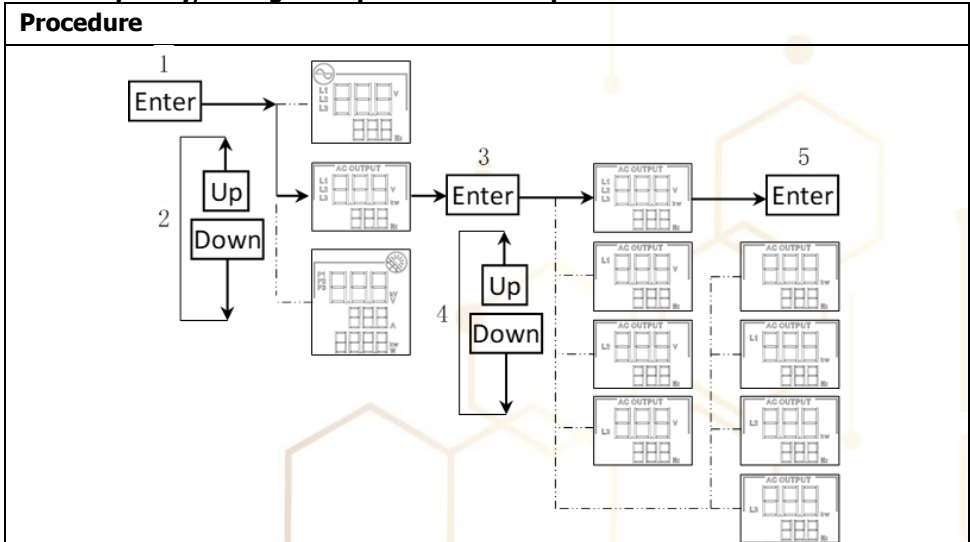
- Input voltage and frequency of AC input.
- Frequency, voltage and power of AC output.
- Input voltage, power and current of PV input.

### Setting Display Procedure

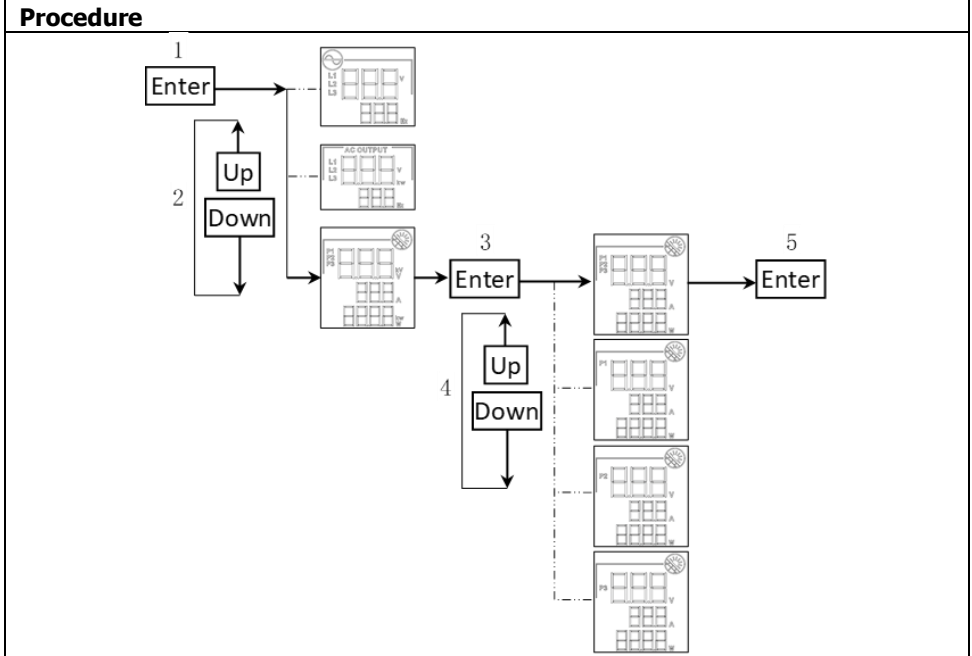
#### ● Input voltage and frequency of AC input



#### ● Frequency, voltage and power of AC output



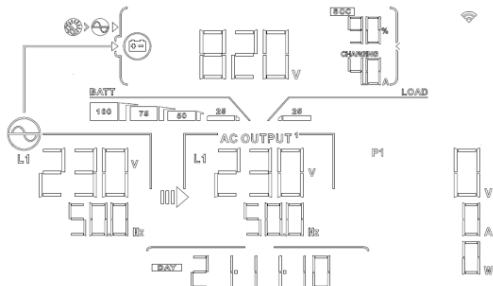
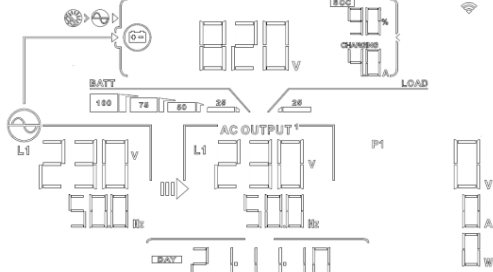
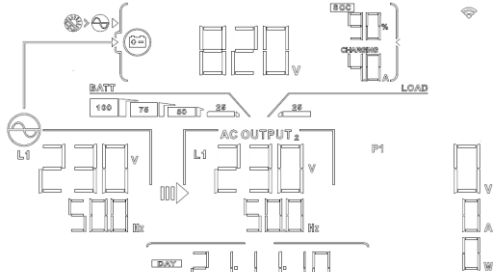
● **Input voltage and power of PV input.**

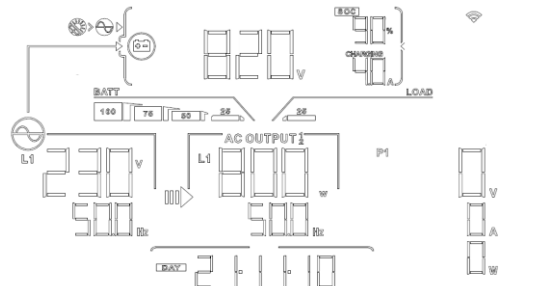
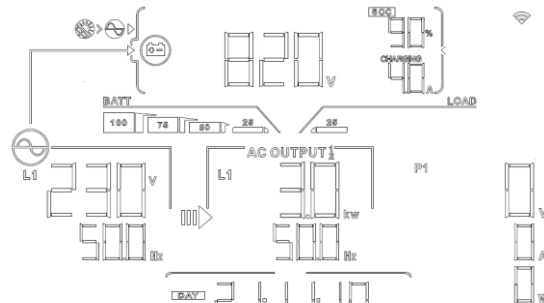
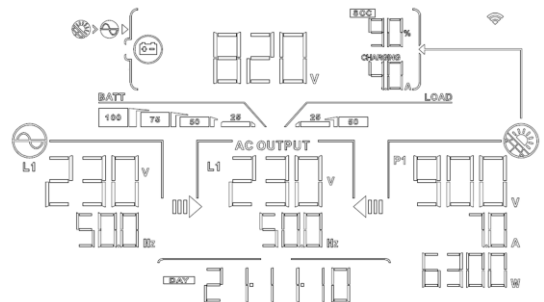


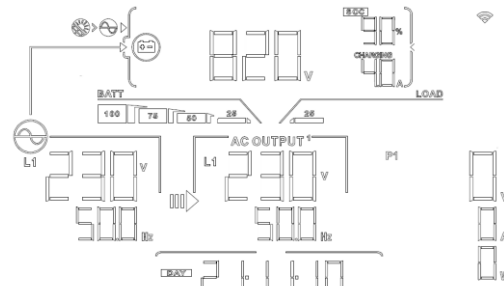
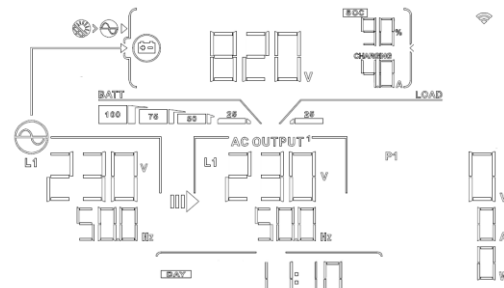
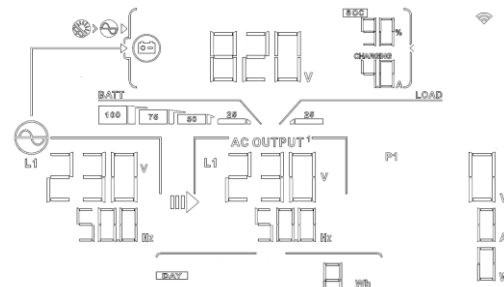
**Switch LCD Displayed Information**

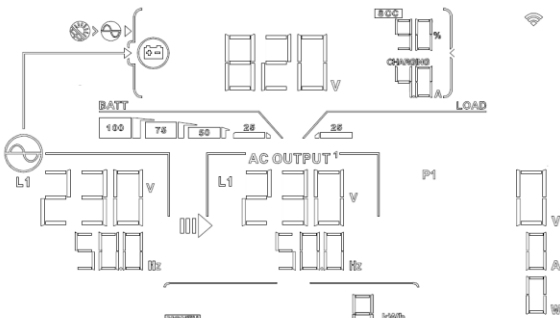
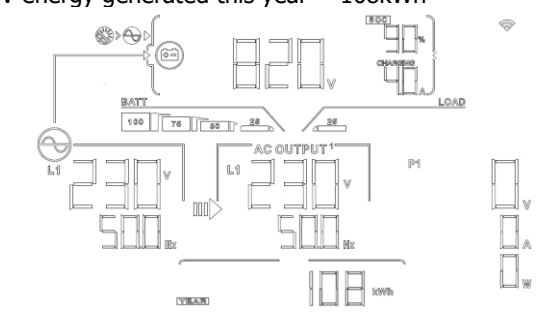
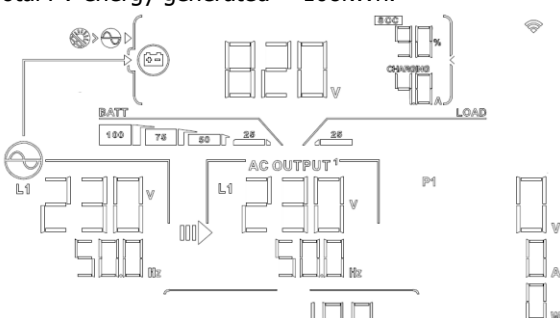
The LCD display information will be switched in turns by pressing “Up” or “Down” key. The selectable information is switched as the following table in order.

Selectable information	LCD display
Default Display Screen	<p>Battery voltage=820V, Battery percentage=90% Charging current=4.0A,</p> <p>The screenshot shows the LCD display with the following information: Battery voltage (820V), Battery percentage (90%), Charging current (4.0A), AC output voltage (230V), AC output current (500A), and a date/time display (21110). The display also shows 'BATT', 'AG OUTPUT', and 'LOAD' indicators.</p>

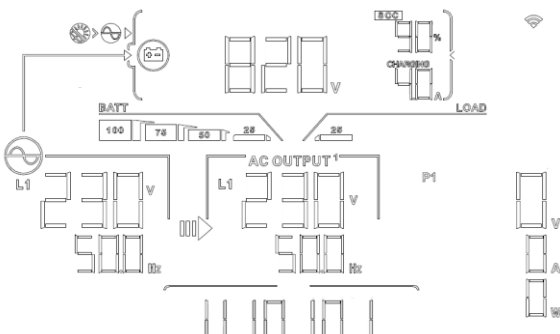
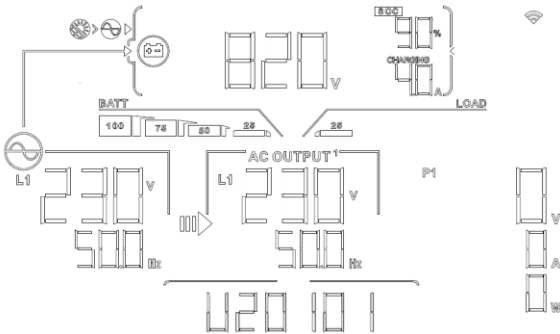
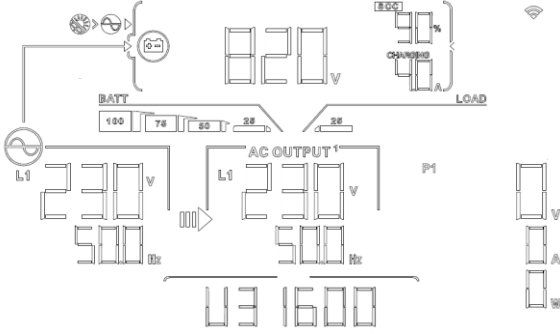
	<p>Input information (R-voltage, S-voltage, T-voltage, switch every 5 second )</p>	<p>R-phase input voltage=230V, Frequency=50.0HZ</p> 
<p>Default Display Screen</p>	<p>Output information (R-voltage, S-voltage, T-voltage, total power, R-power, S-power, T-power switch every 5 second )</p>	<p>Main R-phase output voltage=230V, Frequency=50.0HZ</p> 
		<p><b>Second output (L2)</b> R-phase output voltage=230V, Frequency=50.0HZ</p> 

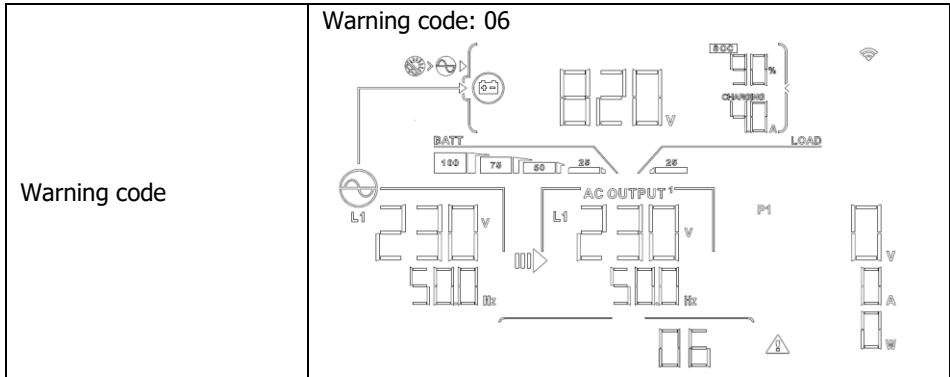
	<p>Output information (R-voltage, S-voltage, T-voltage, total power, R-power, S-power, T-power switch every 5 second )</p>	<p>R-phase output total power=800w</p> 
<p>Default Display Screen</p>	<p>Output information Output information (R-voltage, S-voltage, T-voltage, total power, R-power, S-power, T-power switch every 5 second )</p>	<p>Total power=3kw</p> 
	<p>PV input information (PV1 ,PV2 and PV3 information switch every 5 second )</p>	<p>PV1 input voltage=900V, PV1 input current=7A PV1 input power=6300W</p> 

<p>Default Display Screen</p>	<p>Real Date</p>	<p>Real date: 2021-11-10</p> 
<p>Real time</p>		<p>Real time: 11:10</p> 
<p>PV energy generated today</p>		<p>PV energy generated today =8Wh.</p> 

<p>PV energy generated this month</p>	<p>PV energy generated this month = 8kWh.</p> 
<p>PV energy generated this year</p>	<p>PV energy generated this year = 108kWh</p> 
<p>Total PV energy generated</p>	<p>Total PV energy generated = 108kWh.</p> 



<p>Main CPU version checking</p>	<p>Main CPU version 01.01.</p> 
<p>Secondary CPU version checking</p>	<p>Secondary CPU version 01.01.</p> 
<p>Firmware version checking</p>	<p>Firmware version 16.00</p> 

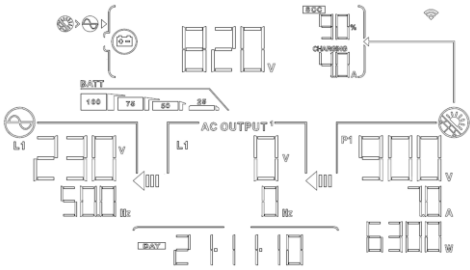
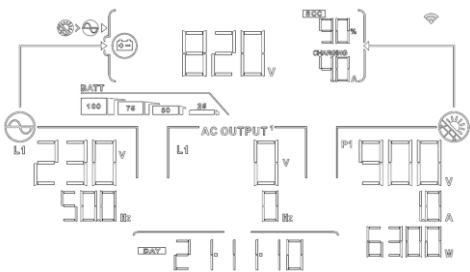
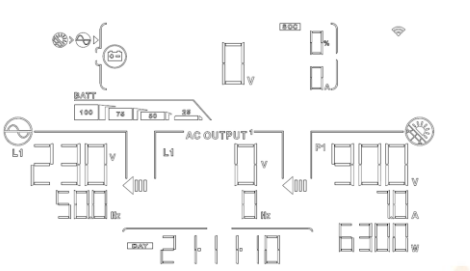
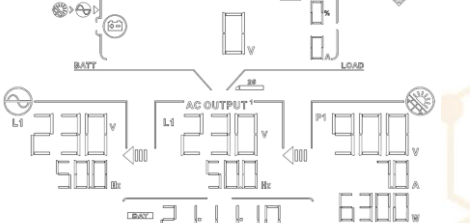


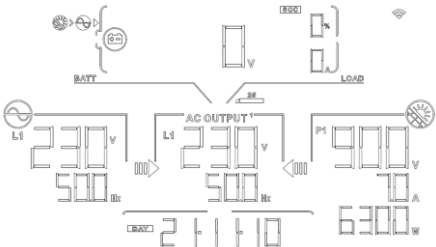
### 14-6. Operation Mode & Display

#### Inverter mode with grid connected

This inverter is connected to grid and working with DC/INV operation.

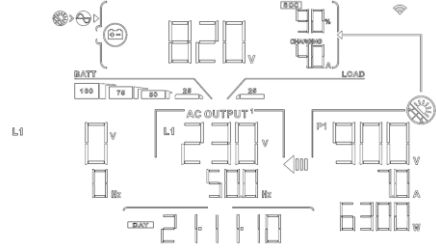
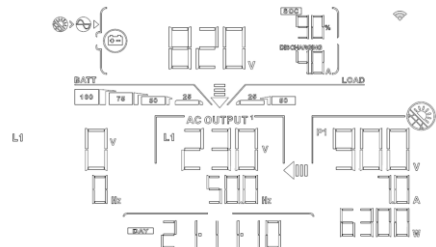
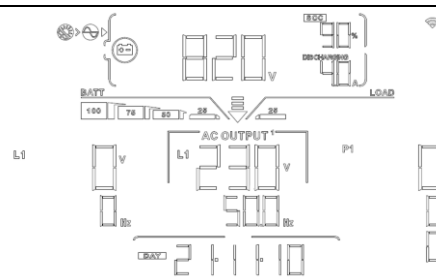
LCD Display	Description
	<p>PV is sufficient to charge battery, provide power to loads, and then feed in to the grid.</p>
	<p>PV power is sufficient to charge the battery first. However, remaining PV power is not sufficient to back up the load. Therefore, remaining PV power and the utility are supplying power to the connected load. If PV power is not sufficient to charge battery by itself, PV power and the utility are charging battery at the same time. And the utility is also supplying power to the connected load.</p>

LCD Display	Description
 <p>The LCD display shows a PV input of 820V and an AC output of 230V. The battery icon is lit, indicating it is charging. The display also shows a battery level of 100% and a power output of 6300W.</p>	<p>This inverter is disabled to generate power to the loads via AC output. PV power is sufficient to charge battery first. Remaining PV power will feed in back to grid.</p>
 <p>The LCD display shows a PV input of 820V and an AC output of 230V. The battery icon is lit, indicating it is charging. The display also shows a battery level of 100% and a power output of 6300W.</p>	<p>This inverter is disabled to generate power to the loads via AC output. PV power and utility are charging battery at the same time because of insufficient PV power.</p>
 <p>The LCD display shows a PV input of 0V and an AC output of 0V. The battery icon is flashing, indicating it is not connected. The display also shows a battery level of 100% and a power output of 6300W.</p>	<p>This inverter is disabled to generate power to the loads via AC output. PV power is feeding power back to the grid. The battery icon flashes to indicated that battery is not connected.</p>
 <p>The LCD display shows a PV input of 0V and an AC output of 230V. The battery icon is flashing, indicating it is not connected. The display also shows a battery level of 100% and a power output of 6300W.</p>	<p>PV power is sufficient to provide power to loads and feeds power back to the grid. The battery icon flashes to indicated that battery is not connected.</p>

LCD Display	Description
 <p>The LCD display shows a battery icon that is flashing, indicating it is not connected. The PV power is 230V, 500Hz. The AC output is 230V, 500Hz. The load is 900V, 70A, 6300W. The battery status is 21110.</p>	<p>PV power and utility are providing power to the connected loads because of insufficient PV power. The battery icon flashes to indicate that the battery is not connected.</p>

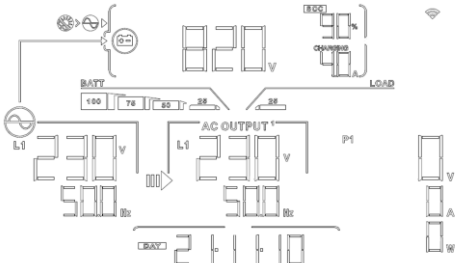
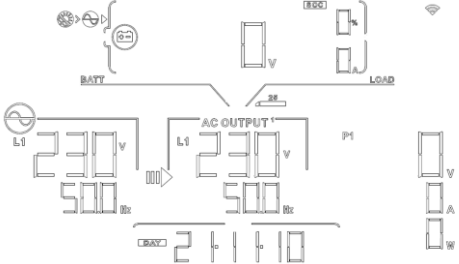
### Inverter mode without grid connected

This inverter is working with DC/INV operation and not connecting to the grid.

LCD Display	Description
 <p>The LCD display shows a battery icon that is solid, indicating it is connected. The PV power is 820V, 90A. The AC output is 230V, 500Hz. The load is 900V, 70A, 6300W. The battery status is 21110.</p>	<p>PV power is sufficient to charge the battery and provide power to the connected loads.</p>
 <p>The LCD display shows a battery icon that is solid, indicating it is connected. The PV power is 820V, 90A. The AC output is 230V, 500Hz. The load is 900V, 70A, 6300W. The battery status is 21110.</p>	<p>PV power is generated, but not sufficient to power loads by itself. PV power and battery are providing power to the connected loads at the same time.</p>
 <p>The LCD display shows a battery icon that is solid, indicating it is connected. The PV power is 820V, 90A. The AC output is 230V, 500Hz. The load is 900V, 70A, 6300W. The battery status is 21110.</p>	<p>Only battery power is available to provide power to connected loads.</p>

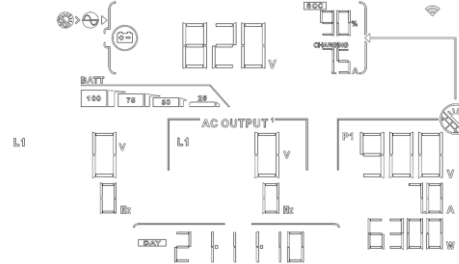
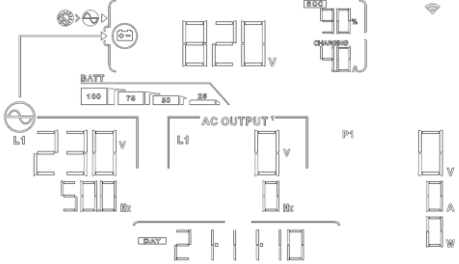
## Bypass mode

The inverter is working without DC/INV operation and connecting to the loads.

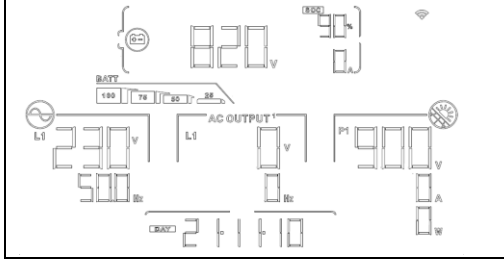
LCD Display	Description
 <p>The LCD display shows utility power at 820V. The battery status is shown as a solid battery icon, and the AC output is shown as a solid '0'.</p>	<p>Only utility is charging battery and providing power to connected loads.</p>
 <p>The LCD display shows utility power at 820V. The battery status is shown as a flashing battery icon, and the AC output is shown as a solid '0'.</p>	<p>Only utility is available to provide power to connected loads. The battery icon flashes to indicated that battery is not connected.</p>

## Standby mode :

The inverter is working without DC/INV operation and load connected.

LCD Display	Description
 <p>The LCD display shows utility power at 820V. The battery status is shown as a flashing battery icon, and the AC output is shown as a solid '900' with a warning icon.</p>	<p>This inverter is disabled on AC output or even AC power output is enabled, but an error occurs on AC output. Only PV power is sufficient to charge battery.</p>
 <p>The LCD display shows utility power at 820V. The battery status is shown as a flashing battery icon, and the AC output is shown as a solid '0'.</p>	<p>This inverter is disabled to generate power to the loads via AC output. PV power is not detected or available at this moment. Only utility is available to charge battery.</p>

## LCD Display



## Description

If PV, battery or utility icons are flashing, it means they are not within acceptable working range. If they are not displayed, it means they are not detected.

## 15. Charging Management

Charging Parameter	Default Value	Note
Charging current	10A	It can be adjusted via software from 1Amp to 50Amp.
Floating charging voltage (default)	691.0 Vdc	It can be adjusted via software from 600Vac to 950Vdc.
Max. absorption charging voltage (default)	691.0 Vdc	It can be adjusted via software from 600Vac to 950Vdc.
Battery overcharge protection loss point	700.0 Vdc	It can be adjusted from 600Vdc to 1000Vdc.
Battery overcharge protection back point	Loss point-20V	
<p>Charging process based on default setting.</p> <p>3 stages:</p> <p>First – max. charging voltage increases to 691V;</p> <p>Second- charging voltage will maintain at 691V until charging current is down to 2 Amp;</p> <p>Third- go to floating charging at 691V.</p>		

This inverter can connect to battery types of sealed lead acid battery, vented battery, gel battery and lithium battery. The detail installation and maintenance explanations of the external battery pack are provided in the manufacturer's external battery pack of manual.

If using sealed lead acid battery, please set up the max. charging current according to below formula:

$$\text{The maximum charging current} = \text{Battery capacity (Ah)} \times 0.2$$

For example, if you are using 300 Ah battery, then, maximum charging current is  $300 \times 0.2 = 60$  (A). Please use at least 50Ah battery because the settable minimum value of charging current is 10A. If using AGM/Gel or other types of battery, please consult with installer for the details.

Below is setting screen from bundled software:

**Parameters setting**

Min. grid-connected voltage: 184 V	Apply	The waiting time before grid-connection: 60 Sec.	Apply
Max. grid-connected voltage: 264.5 V	Apply	Max. grid-connected average voltage: 253 V	Apply
Min. grid-connected frequency: 47.48 Hz	Apply	Max. feed-in grid power: 10,000 W	Apply
Max. grid-connected frequency: 51.5 Hz	Apply		
Min. PV input voltage: 300 V	Apply	Floating charging voltage: 54 V	Apply
Max. PV input voltage: 900 V	Apply	Battery cut-off discharging voltage when Grid is available: 48 V	Apply
Min. MPP voltage: 350 V	Apply	Battery re-discharging voltage when Grid is available: 54 V	Apply
Max. MPP voltage: 850 V	Apply	Battery cut-off discharging voltage when Grid is unavailable: 42 V	Apply
Max. charging current: 60 A	Apply	Battery re-discharging voltage when Grid is unavailable: 48 V	Apply
Max. AC charging current: 60 A	Apply	Battery temperature compensation: 0 mV	Apply
Bulk charging voltage(C.V. voltage): 56 V	Apply	Feeding grid power calibration: 0 W	Apply
Start LCD screen-saver after: None Sec.	Apply	Max. battery discharge current in hybrid mode: 10 A	Apply
Mute Buzzer alarm: <input type="radio"/> Enable <input checked="" type="radio"/> Disable	Apply	Generator as AC source: <input type="radio"/> Enable <input checked="" type="radio"/> Disable	Apply
Mute the buzzer in the Standby mode: <input type="radio"/> Enable <input checked="" type="radio"/> Disable	Apply	Activate Li-Fe battery while commissioning: <input type="radio"/> Yes <input checked="" type="radio"/> No	Apply
Mute alarm in battery mode: <input type="radio"/> Enable <input checked="" type="radio"/> Disable	Apply	Wide AC input range: <input type="radio"/> Enable <input checked="" type="radio"/> Disable	Apply

When float charging current is less than X (A) and continued T (Min),then charger off, when battery voltage is less than Y (V),then charger on again.

X: 0 A T: 60 Min. Y: 53 V Apply

Any schedule change will affect the power generated and shall be conservatively made.

System time: 2014-10-27

14:03:21 Apply

Close



## 16. Maintenance & Cleaning

Check the following points to ensure proper operation of whole solar system at regular intervals.

- Ensure all connectors of this inverter are cleaned all the time.
- Before cleaning the solar panels, be sure to turn off PV DC breakers.
- Clean the solar panels, during the cool time of the day, whenever it is visibly dirty.
- Periodically inspect the system to make sure that all wires and supports are securely fastened in place.

**WARNING:** There are no user-replaceable parts inside of the inverter. Do not attempt to service the unit yourself.

### Battery Maintenance

- Servicing of batteries should be performed or supervised by personnel knowledgeable about batteries and the required precautions.
- When replacing batteries, replace with the same type and number of batteries or battery packs.
- The following precautions should be observed when working on batteries:
  - a) Remove watches, rings, or other metal objects.
  - b) Use tools with insulated handles.
  - c) Wear rubber gloves and boots.
  - d) Do not lay tools or metal parts on top of batteries.
  - e) Disconnect charging source prior to connecting or disconnecting battery terminals.
  - f) Determine if battery is inadvertently grounded. If inadvertently grounded, remove source from ground. Contact with any part of a grounded battery can result in electrical shock. The likelihood of such shock can be reduced if such grounds are removed during installation and maintenance (applicable to equipment and remote battery supplies not having a grounded supply circuit).

**CAUTION:** A battery can present a risk of electrical shock and high short-circuit current.

**CAUTION:** Do not dispose of batteries in a fire. The batteries may explode.



**CAUTION:** Do not open or mutilate batteries. Released electrolyte is harmful to the skin and eyes. It may be toxic.





















## 17. Trouble Shooting

When there is no information displayed in the LCD, please check if PV module/battery/grid connection is correctly connected.

**NOTE:** The warning and fault information can be recorded by remote monitoring software.

### 17-1. Warning List

There are 20 situations defined as warnings. When a warning situation occurs,  icon will flash and  will display warning code. If there are several codes, it will display in sequences. Please contact your installer when you couldn't handle with the warning situations.

Code	Warning Event	Icon (flashing)	Description
01	Line voltage high loss		Grid voltage is too high.
02	Line voltage low loss		Grid voltage is too low.
03	Line frequency high loss		Grid frequency is too high.
04	Line frequency low loss		Grid frequency is too low.
05	Line voltage loss for long time		Grid voltage is higher than 253V.
06	Ground Loss		Ground wire is not detected.
07	Island detect		Island operation is detected.
08	Line waveform loss		The waveform of grid is not suitable for inverter.
09	Line phase loss		The phase of grid is not in right sequence.
10	EPO detected		EPO is open.
11	Overload		Load exceeds rating value.
12	Over temperature		The temperature is too high inside.
13	Batter voltage low		Battery discharges to low alarm point.
14	Battery under-voltage when grid is loss		Battery discharges to shutdown point.
15	Battery open		Battery is unconnected or too low.
16	Battery under-voltage when grid is OK		Battery stops discharging when the grid is OK.
17	Solar over voltage		PV voltage is too high.
b0	Stop discharging battery		Informs inverter to stop discharging battery.
b1	Stop charging battery		Informs inverter to stop charging battery
b2	Charge battery		Informs inverter to charge battery.

## 17-2. Fault Reference Codes

When a fault occurs, refer to below table to solve problem.

Situation			Solution
Fault Code	Fault Event	Possible cause	
01	Bus voltage over	Surge	1. Restart the inverter. 2. If the error message still remains, please contact your installer.
02	BUS voltage under	PV or battery disconnect suddenly	1. Restart the inverter 2. If the error message still remains, please contact your installer.
03	BUS soft start time out	Internal components failed.	Please contact your installer.
04	INV soft start time out	Internal components failed.	Please contact your installer.
05	R phase INV over current	Surge	1. Restart the inverter. 2. If the error message still remains, please contact your installer.
06	Over temperature	Internal temperature is too high.	1. Check the ambient temperature and fans. 2. If the error message still remains, please contact your installer.
07	Relay fault	Internal components failed.	Please contact your installer.
08	DC CT sensor fault	Internal components failed.	Please contact your installer.
09	Solar input power abnormal	1. Solar input driver damaged. 2. Solar input power is too much when voltage is more than 850V.	1. Please check if solar input voltage is higher than 850V. 2. Please contact your installer.
11	Solar over current	Surge	1. Restart the inverter. 2. If the error message still remains, please contact your installer.
12	GFCI fault	Leakage current exceeds the limit.	1. Check the wire and panels which may cause the leakage.

13	PV ISO fault	The resistance between PV and ground is too low.	2. If the error message still remains, please contact your installer.
14	R phase INV DC current over	Utility fluctuates.	1. Restart the inverter. 2. If the error message still remains, please contact your installer.
16	GFCI sensor fault	GFCI sensor failed.	Please contact your installer.
17	DSP and MCU Com. Loss	Communication loss between DSP and MCU	Please contact your installer.
22	Battery high voltage fault	Battery voltage exceeds the limit.	1. Check the battery voltage. 2. If the error message still remains, please contact your installer.
23	Over load	The inverter is loaded with more than 110% load and time is up.	Reduced the connected load by switching off some equipment.
24	S phase INV over current	Surge	1. Restart the inverter. 2. If the error message still remains, please contact your installer.
25	T phase INV over current	Surge	1. Restart the inverter. 2. If the error message still remains, please contact your installer.
26	INV short	Output short circuited.	Check if wiring is connected well and remove abnormal load.
27	Fan lock	Fan failure	Please contact your installer.
29	INV CT sensor fault	Internal components failure	Please contact your installer.
30	S phase INV DC current over	Utility fluctuates.	1. Restart the inverter. 2. If the error message still remains, please contact your installer.
31	T phase INV DC current over	Utility fluctuates.	1. Restart the inverter. 2. If the error message still remains, please contact your installer.
32	DC/DC over current	Battery voltage	1. Restart the inverter.

		fluctuates.	2. If the error message still remains, please contact your installer.
33	R phase INV voltage low	Internal components failed.	Please contact your installer.
34	R phase INV voltage high	Internal components failed.	Please contact your installer.
35	Wire connection fault	Internal wires loosen.	Please contact your installer.
36	OP voltage fault	Grid connects to output terminal	Don't connect the grid to the output terminal.
37	N Line over current	Utility fluctuates.	Please contact your installer.
38	Short circuited on PV input	Short circuited on PV input	Please contact your installer.
39	S phase INV voltage low	Internal components failed.	Please contact your installer.
40	T phase INV voltage low	Internal components failed.	Please contact your installer.
41	S phase INV voltage high	Internal components failed.	Please contact your installer.
42	T phase INV voltage high	Internal components failed.	Please contact your installer.
50	Incompatible inverter firmware	Inverter hardware does not match firmware.	Please contact your installer.
51	Exit battery over temperature	Exit battery temperature is too high.	1. Check the ambient temperature and fans. 2. If the error message still remains, please contact your installer.
52	P1 over temperature	Temperature is too high on P1.	1. Check the ambient temperature and fans. 2. If the error message still remains, please contact your installer.
53	P2 over temperature	Temperature is too high on P2.	1. Check the ambient temperature and fans. 2. If the error message still remains, please contact your installer.
55	R phase INV over temperature	R phase INV temperature is too	1. Check the ambient temperature and fans.

		high.	2. If the error message still remains, please contact your installer.
56	S phase INV over temperature	S phase INV temperature is too high.	1. Check the ambient temperature and fans. 2. If the error message still remains, please contact your installer.
57	T phase INV over temperature	T phase INV temperature is too high.	1. Check the ambient temperature and fans. 2. If the error message still remains, please contact your installer.
58	DC/DC over temperature	DC/DC temperature is too high.	1. Check the ambient temperature and fans. 2. If the error message still remains, please contact your installer.

## 18. Specifications

<b>MODEL</b>	<b>30KW</b>
<b>RATED OUTPUT POWER</b>	30000W
<b>PV INPUT (DC)</b>	
Max. PV Power	40000W
Nominal DC Voltage	720Vdc
Max. PV Array Open Circuit Voltage	1000 VDC
Working voltage range	350 ~ 1000 VDC
MPPT Range @ Operating Voltage	350 VDC~900 VDC
Full power MPPT range	500 ~ 900Vdc ( $\pm 10$ Vdc)
Max. PV Array Short Circuit Current	PV1:26A PV2:26A PV3:26A
Number of MPP Tracker	3
<b>GRID-TIE OPERATION</b>	
<b>GRID OUTPUT (AC)</b>	
Nominal Output Voltage	220/230/240 VAC
Max feeding power	30000W
Feed-in Grid Voltage Range	184 - 265 VAC per phase
Feed-in Grid Frequency Range	47.5 ~ 51.5 Hz or 59.3~ 60.5Hz
Nominal Output Current	43.5 A per phase
Power Factor Range	>0.99
Maximum Conversion Efficiency (DC/AC)	96.5%
<b>OFF-GRID, HYBRID OPERATION</b>	
<b>GRID INPUT</b>	
Acceptable Input Voltage Range	170~290 VAC per phase
Frequency Range	50 Hz/60 Hz (Auto sensing)
Max. AC Input current	50Amp per phase
<b>GENERATOR INPUT</b>	
Maximum Input Power	30000W
Acceptable Input Voltage Range	170~290 VAC per phase
Acceptable Input Frequency Range	40.0 ~ 60.0 Hz or 50.0.~ 70.0Hz
Maximum AC Input Current	50Amp per phase
<b>BATTERY MODE OUTPUT (AC)</b>	
Nominal Output Voltage	220/230/240 VAC
Output Waveform	Pure Sine Wave
Efficiency (DC to AC)	96%

Output Power	30000W
<b>BATTERY &amp; CHARGER</b>	
Nominal DC Voltage	614.4 VDC
Maximum Charging Current	50A
<b>GENERAL</b>	
Dimension, D X W X H (mm)	255 x 660 x 750
Net Weight (kgs)	73
<b>INTERFACE</b>	
Parallel-able	Yes
External Safety Box (Optional)	Yes
Communication	USB, RS232, RS 485, WiFi
<b>ENVIRONMENT</b>	
Humidity	0 ~ 95% RH (No condensing)
Operating Temperature	-25°C to 50°C



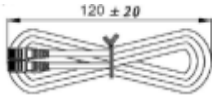
# Appendix I: Parallel Installation Guide

## Introduction

This inverter can be used in parallel with maximum 4 units.

## Parallel cable

You will find the following items in the package:

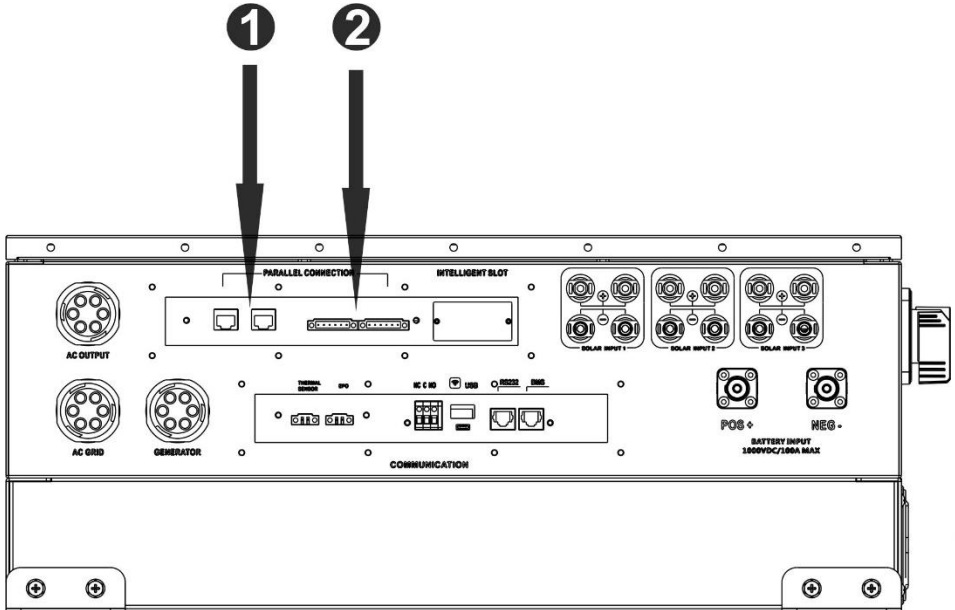


Parallel communication cable



Current sharing cable

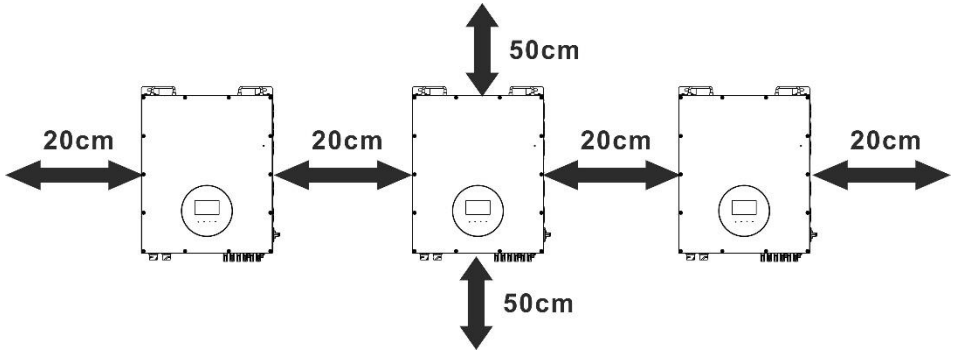
## Overview



1. Parallel communication port
2. Current sharing port

## Mounting the Unit

When installing multiple units, please follow below chart.



**NOTE:** For proper air circulation to dissipate heat, it's necessary to allow a clearance of approx. 50 cm to the side and approx. 20 cm above and below the unit. Be sure to install each unit in the same level.

## Wiring Connection

The cable size of each inverter is shown as below:

### Recommended battery cable size for each inverter:

Model	AWG no.	Torque
30KW	1*4AWG	5.5~7 Nm

**WARNING1:** Be sure the length of all battery cables is the same. Otherwise, there will be voltage difference between inverter and battery to cause parallel inverters not working.

**WARNING2:** The battery of each inverter must be independent.

### Recommended AC input and output cable size for each inverter:

Model	AWG no.	Torque
30KW	8 AWG	1.2~1.6Nm

You need to connect the cables of each inverter together. Take the battery cables for example. You need to use a connector or bus-bar as a joint to connect the battery cables together, and then connect to the battery terminal. The cable size used from joint to battery should be X times cable size in the tables above. "X" indicates the number of inverters connected in parallel.

Regarding cable size of AC input and output, please also follow the same principle.

**CAUTION!!** Please install a breaker at the battery side. This will ensure the inverter can

be securely disconnected during maintenance and fully protected from overcurrent of battery.

**Recommended breaker specification of battery for each inverter:**

Model	1 unit*
30KW	200A/1000VDC

\*If you want to use only one breaker at the battery side for the whole system, the rating of the breaker should be X times current of one unit. "X" indicates the number of inverters connected in parallel.

**Recommended breaker specification of AC input with three phase:**

Model	2 units	3 units	4 units
30KW	100A/230VAC	150A/230VAC	200A/230VAC

**Note1:** Also, you can use 50A breaker for 30KW for only 1 unit and install one breaker at its AC input in each inverter.

**Note2:** Regarding three-phase system, you can use 4-pole breaker directly and the rating of the breaker should be compatible with the phase current limitation from the phase with maximum units

**Recommended battery capacity**

Inverter parallel numbers	2	3	4
Battery Capacity	200AH x 2	200AH x 3	200AH x 4

**WARNING!** The battery of each inverter must be independent.

**PV Connection**

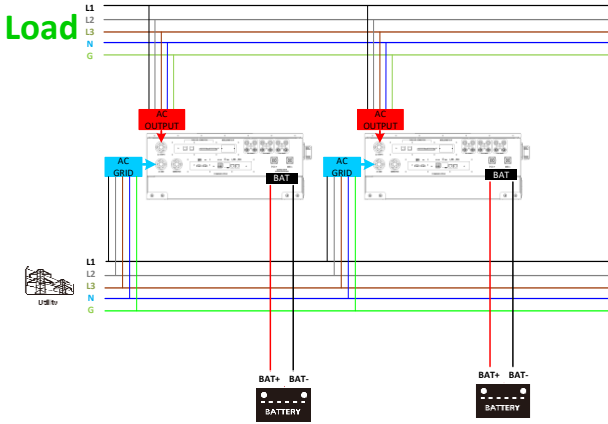
Please refer to user manual of single unit for PV Connection.

**CAUTION:** Each inverter should connect to PV modules separately.

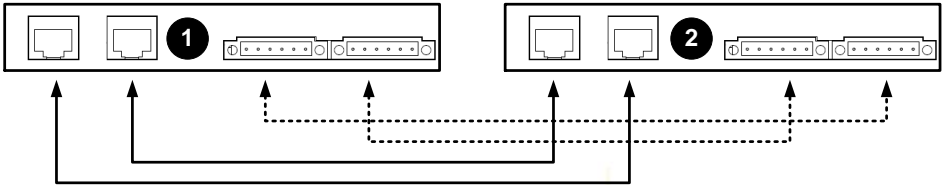
## Inverters Configuration

Two inverters in parallel:

### Power Connection

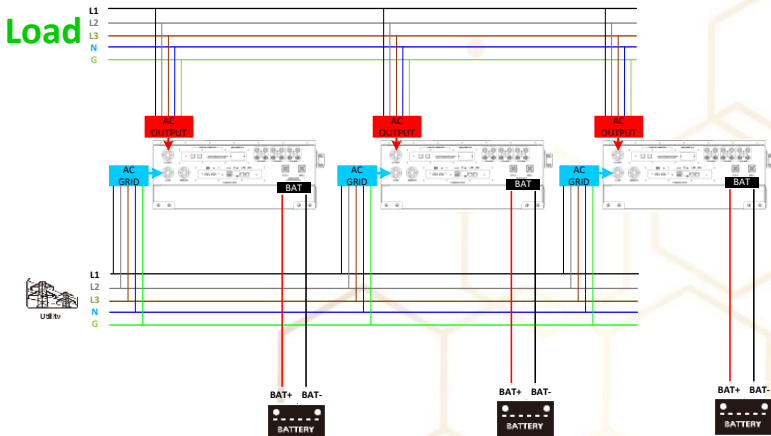


### Communication Connection

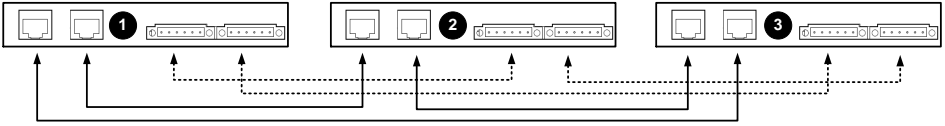


Three inverters in parallel:

### Power Connection



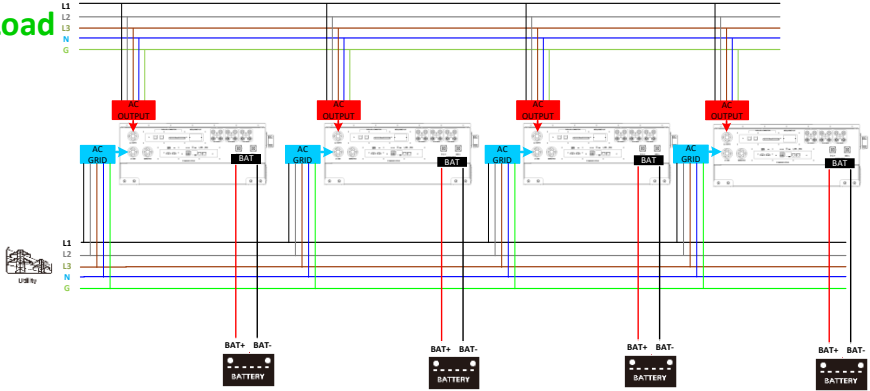
## Communication Connection



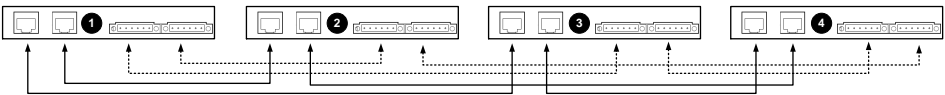
Four inverters in parallel:

## Power Connection

### Load



## Communication Connection



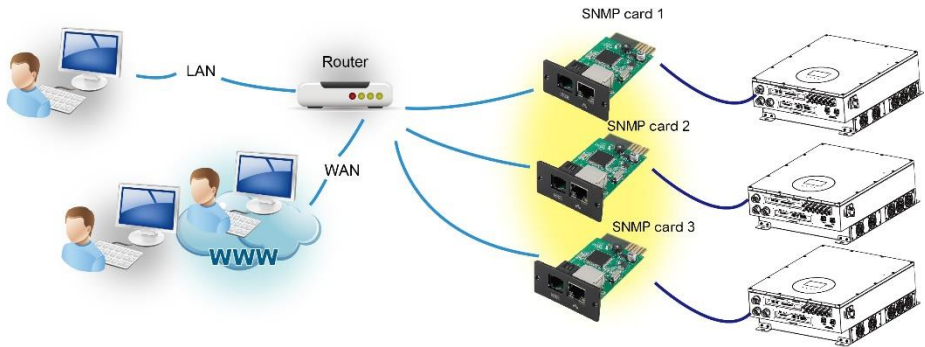
## Setting and LCD Display Setting Program:

The parallel function setting is only available with bundled software - SolarPower. Please install SolarPower in your PC first.

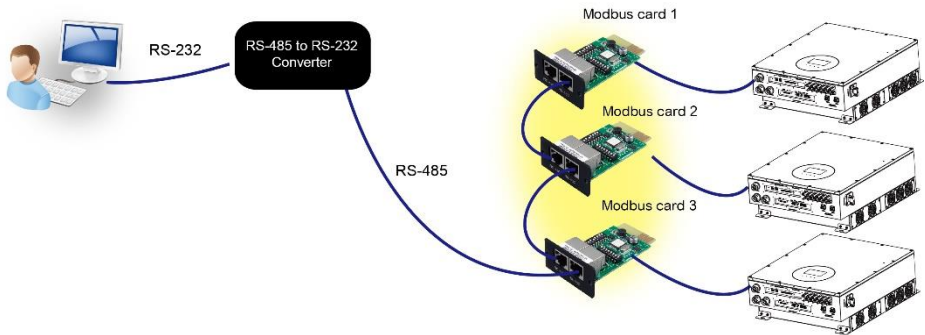
For setting, you can set the inverter one by one through RS232 or USB port.

But we suggest to use SNMP or Modbus card to combine the system as a centralized monitoring system. Then, you can use "SYNC" function to set all the inverters at the same time. If using SNMP or Modbus card to set up program, the bundled software is SolarPower Pro.

- Use SNMP card to synchronize the parameters:  
Each inverter should be installed one SNMP card. Make sure all of the SNMP cards are connected to the router as a LAN.



- Use Modbus card to synchronize the parameters:  
Each inverter should be installed one Modbus card. Make sure all of the Modbus cards are connected to each other and one of the Modbus cards is connected to the computer by RS-485/RS232 converter.



Launch SolarPowerPro in computer and select Device Control >> Parameter Setting >> Parallel output. Two options: Enable or Disable.

If you want to use parallel function, please choose "Enable" and press "Apply"

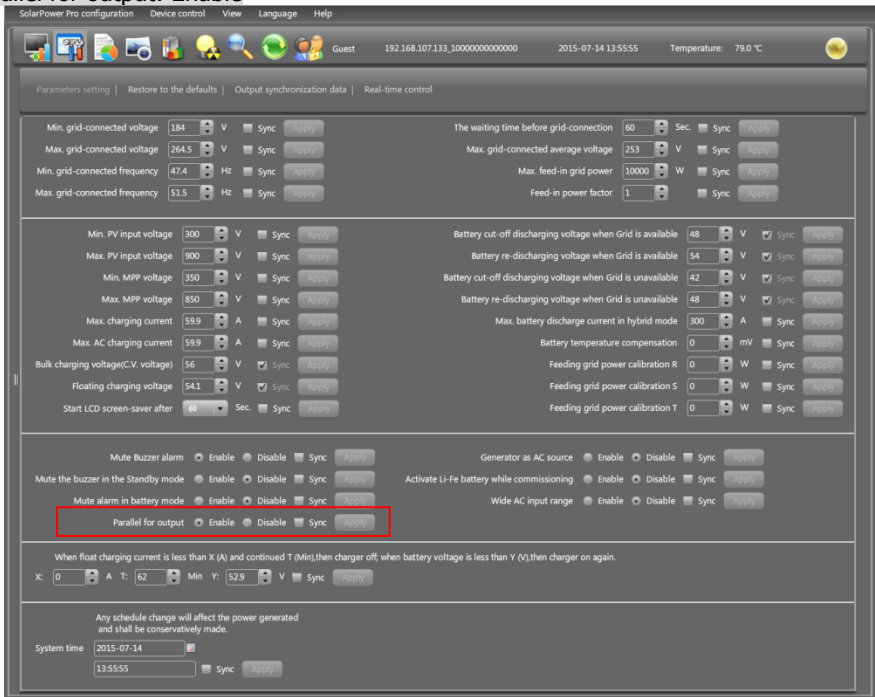


button. Then, “ Sync” button will be shown is the screen. Please be sure to click “ Sync” button before clicking “Apply” button.

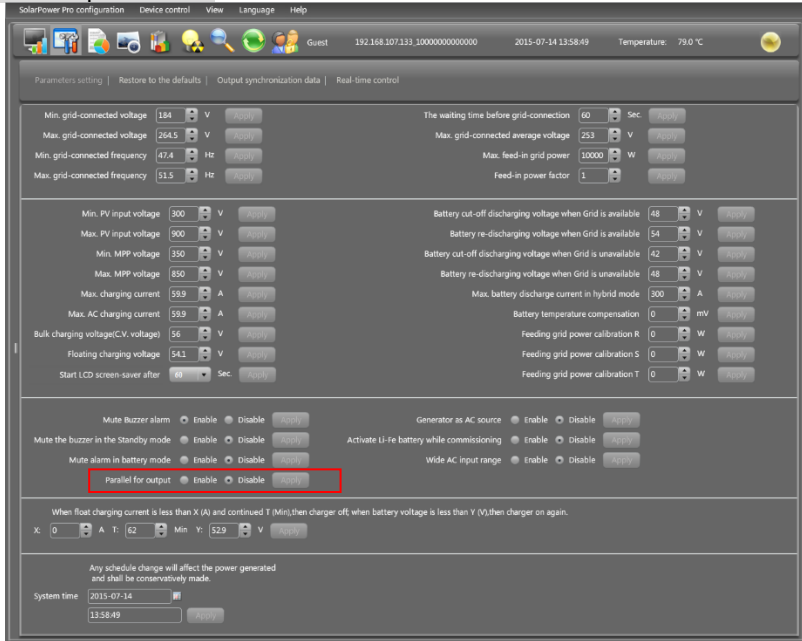
There is a “Sync” button in each parameter setting. When “Sync” is clicked and “Apply” is pressed, this new setting will be applied to all inverters. If not, this setting is only effected in current inverter you choose.

**Note:** Without centralized monitoring system, “Sync” function is not effective. Then, you have to set up the inverter one by one through serial communication port.

### Parallel for output: Enable



## Parallel for output: Disable



## Fault code display:

Fault Code	Fault Event	Icon on
60	Power feedback protection	F60 FAULT
71	Firmware version inconsistent	F71 FAULT
72	Current sharing fault	F72 FAULT
80	CAN fault	F80 FAULT
81	Host loss	F81 FAULT
82	Synchronization loss	F82 FAULT



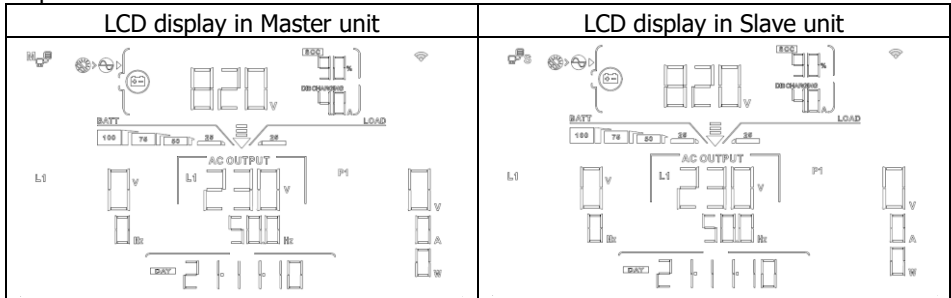
## Commissioning

Step 1: Check the following requirements before commissioning:

- Correct wire connection.
- Ensure all breakers in Line wires of load side are open and each Neutral wire of each unit is connected together.

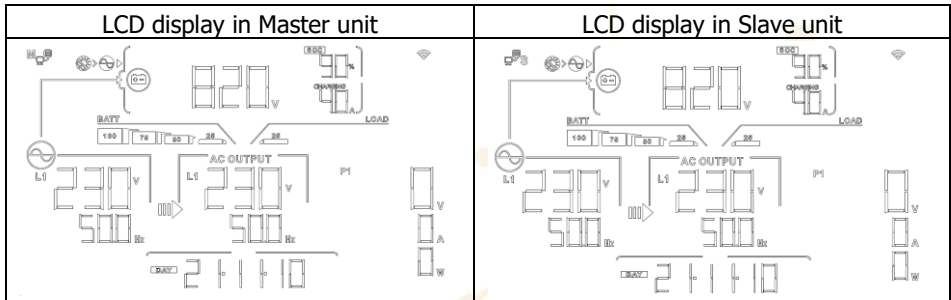
Step 2: Turn on each unit and set "enable parallel for output" on SolarPower or SolarPower Pro. And then, shut down all units.

Step 3: Turn on each unit.



**NOTE:** Master and slave units are randomly defined. Warning 02 is AC GRID voltage low.

Step 4: Switch on all AC breakers of Line wires in AC input. It's better to have all inverters connect to utility at the same time. If not, it will display fault 82 in following-order inverters. However, these inverters will automatically restart. If detecting AC connection, they will work normally.



Step 5: If there is no more fault alarm, the parallel system is completely installed.

Step 6: Please switch on all breakers of Line wires in load side. This system will start to provide power to the load.

## Trouble shooting

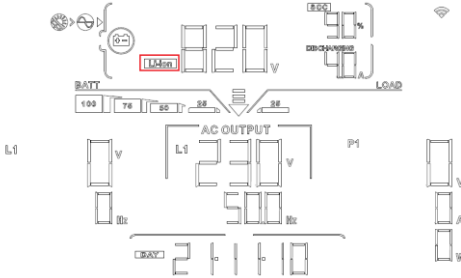
Situation		Solution
Fault Code	Fault Event Description	
37	Over current on Neutral wire	<ol style="list-style-type: none"> <li>1. Remove excessive loads.</li> <li>2. Restart the inverter.</li> <li>3. If the problem remains, please contact your installer.</li> </ol>
60	Current feedback into the inverter is detected.	<ol style="list-style-type: none"> <li>4. Restart the inverter.</li> <li>5. Check if L1/L2/L3/N cables are not connected with wrong sequence in all inverters.</li> <li>6. Make sure the sharing cables are connected in all inverters.</li> <li>7. If the problem remains, please contact your installer.</li> </ol>
61	Relay board driver loss,	<ol style="list-style-type: none"> <li>1. Disconnect all of power source.</li> <li>2. Only connect AC input and press Enter key to let it working in bypass mode.</li> <li>3. Check if the problem happens again or not and feed back the result to your installer.</li> </ol>
62	Relay board communication loss,	
71	The firmware version of each inverter is not the same.	<ol style="list-style-type: none"> <li>1. Update all inverter firmware to the same version.</li> <li>2. After updating, if the problem still remains, please contact your installer.</li> </ol>
72	The output current of each inverter is different.	<ol style="list-style-type: none"> <li>1. Check if sharing cables are connected well and restart the inverter.</li> <li>2. If the problem remains, please contact your installer.</li> </ol>
80	CAN data loss	<ol style="list-style-type: none"> <li>1. Check if communication cables are connected well and restart the inverter.</li> <li>2. If the problem remains, please contact your installer.</li> </ol>
81	Host data loss	
82	Synchronization data loss	

## Appendix II: BMS

### 1. BMS port pin define:

	Definition
PIN 3	RS485B
PIN 5	RS485A
PIN 8	GND

### 2. After all wires are connected well and the communication between the inverter and battery is successful, it will show successful icon on the LCD screen.



### 3. Code Reference

Related information code will be displayed on LCD screen. Please check inverter LCD screen for the operation.

Code	Description
	Informs inverter to stop discharging battery.
	Informs inverter to stop charging battery
	Informs inverter to charge battery.

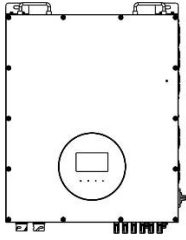
# Appendix III: Wi-Fi Operation Guide

## 1. Introduction

Wi-Fi module can enable wireless communication between solar inverters and monitoring platform. Users have complete and remote monitoring and controlling experience for inverters when combining Wi-Fi module with Energy-mate APP, available for both iOS and Android based device. All data loggers and parameters are saved in iCloud.

The major functions of this APP:

- Delivers device status during normal operation.
- Allows to configure device setting after installation.
- Notifies users when a warning or alarm occurs.
- Allows users to query inverter history data.



## 2. Energy- mate App

### 2-1. Download and install APP

***Operating system requirement for your smart phone:***

 iOS system supports iOS 9.0 and above

 Android system supports Android 5.0 and above

Please scan the following QR code with your smart phone and download Energy- mate App.



Android system





iOS system

Or you may find "Energy-mate" app from the Apple® Store and Google® Play Store.



## 2-2. Initial Setup

### Step 1: Registration at first time

After the installation, please tap the shortcut icon  to access this APP on your mobile screen. In the screen, tap "Register" to access "User Registration" page as shown in below chart. Enter the account registration interface to access registered page as shown in the Figure 2. Fill in all required information and scan the remote box PN by tapping  icon. Or you can simply enter PN directly, as shown in Figure 3. The PN number is 14 digits, which can be obtained from the bottom side of the inverter. Refer to the Figure 4. Then, tap "Sign up now" button.

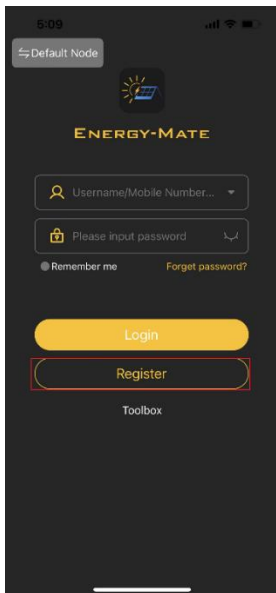


Figure 1

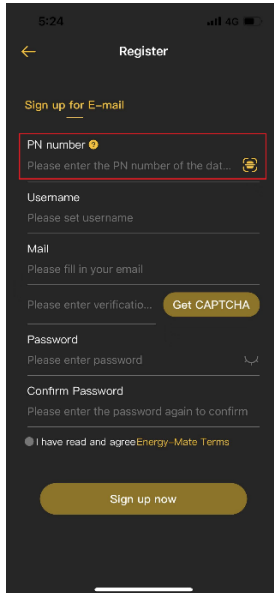


Figure 2

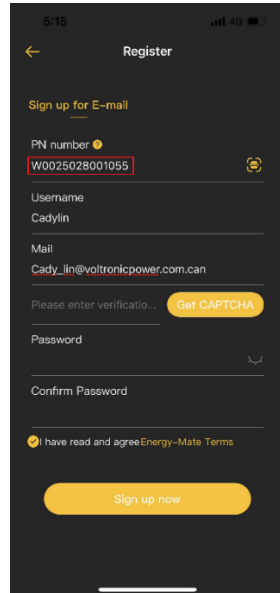


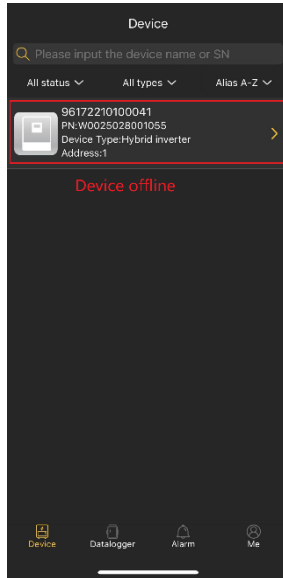
Figure 3



Figure 4

After successful registration, it automatically enters the access "device" page. the

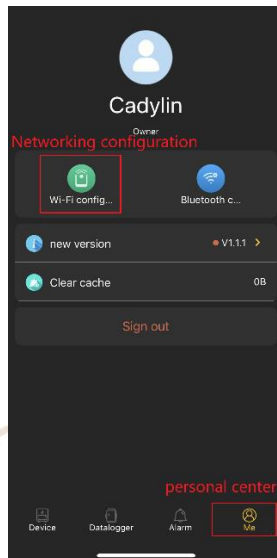
account login interface is shown in Figure 5. The registered device has not been configured for networking and is not online.



**Figure 5**

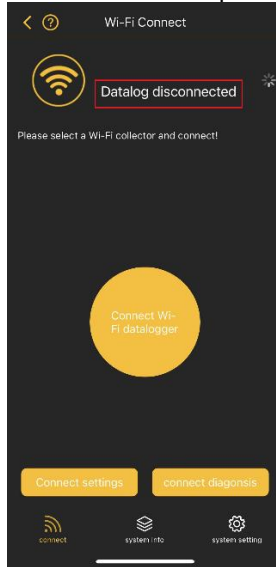
### Step 2: Local Wi-Fi Configuration

Click bottom icon "Me" (Personal Center) to access Networking Configuration as shown in Figure 6.

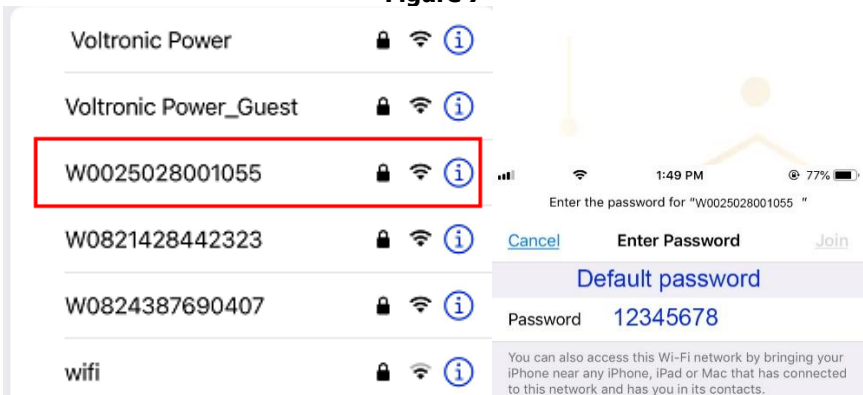


**Figure 6**

The networking configuration page is displayed as shown in Figure 7. The device networking configuration requires the device to be powered on and connected to the device hotspot using the mobile phone, as shown in Figure 8. The connected Wi-Fi name is the same to your Wi-Fi PN number. Enter default password "12345678" as shown in

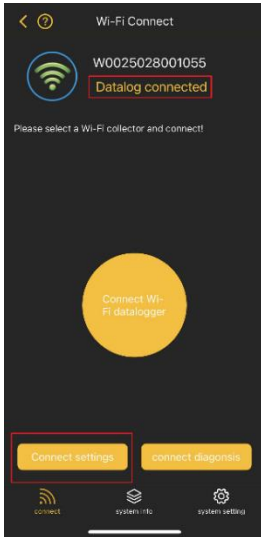


**Figure 7**

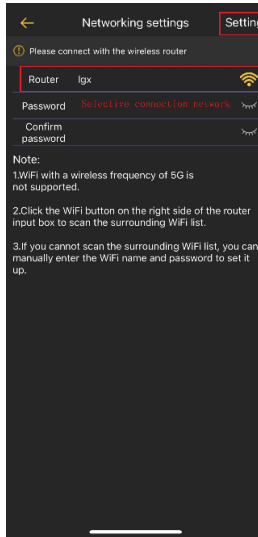


**Figure 8**

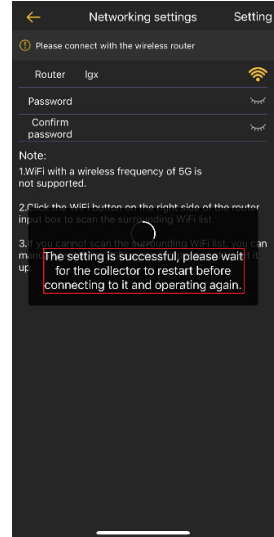
After connecting the device WiFi successfully, enter the network settings and select local WiFi name and enter the password as shown in Figure 9. and Figure 10. The setting is successful as shown in Figure 11.



**Figure 9**



**Figure 10**



**Figure 11**

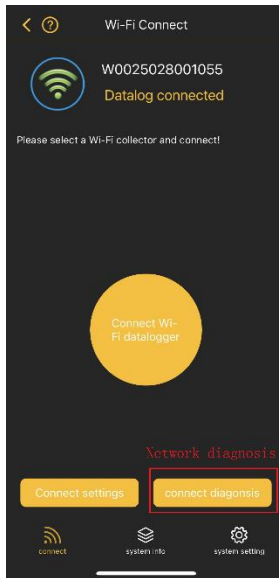
**Tips:**

1. Please ensure that the signal connected to the network is good and the network is unblocked.
2. Currently, routers in 5G band are not supported. Please use routers in 2.4G Band.
3. Make sure that the router password is correct.

**Step 3: View the distribution results**

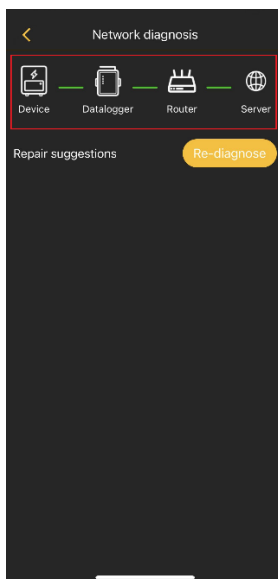
Go back to the main interface of networking configuration and select networking diagnosis, as shown in Figure 12.



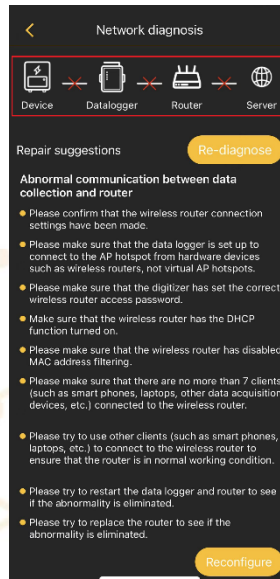


**Figure 12**

Network diagnosis is successfully as shown in Figure 13. If network diagnosis fails, it will show as in Figure 14. If the network connection fails, reconfigure the network or restart the device.



**Figure 13**



**Figure 14**

After network configuration is successfully, you can view the device status as shown in

Figure 15.

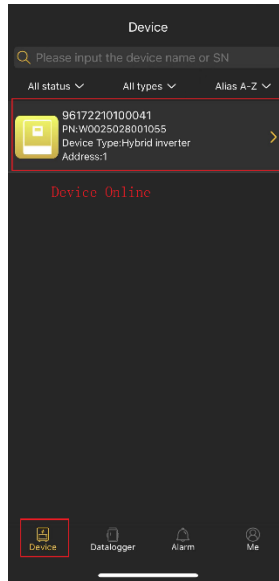


Figure 15

**Tips:**

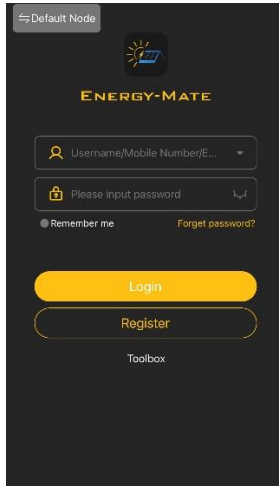
1. If the network configuration fails, troubleshoot the problem according to the repair suggestions on the actual page.
2. Bluetooth pairing: Turn on "Bluetooth" in the "Settings" page of the mobile phone, return to the Energy-mate APP, and select the Bluetooth device with the device PN to connect. (Currently, this feature is not supported.)

**2-3. Login and APP Main Function**

**Login to the APP**

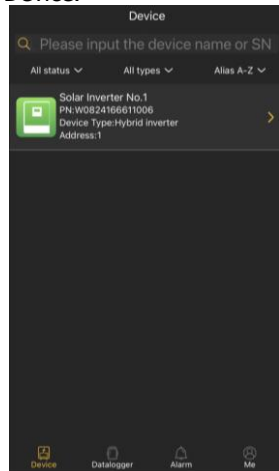
After finishing the registration and local Wi-Fi configuration, enter registered name and password to login.

**Tips:** Tick "Remember me" for your login convenience afterwards.




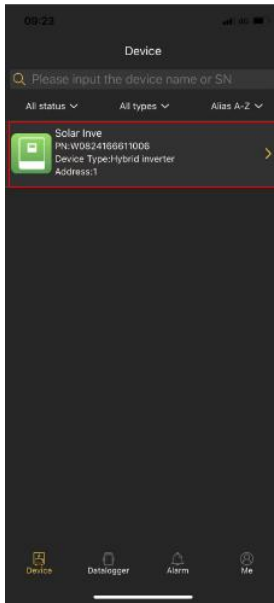
After login is successfully, you can access “device” page to see device status in device list under this registered account.

**Tips:** Tap the input text box (located on the top) to enter the PN number on the device or scan the QR code to Search Device.





### Delete device and Name Modification

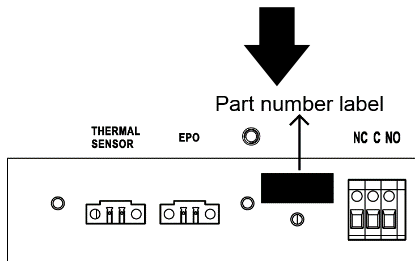
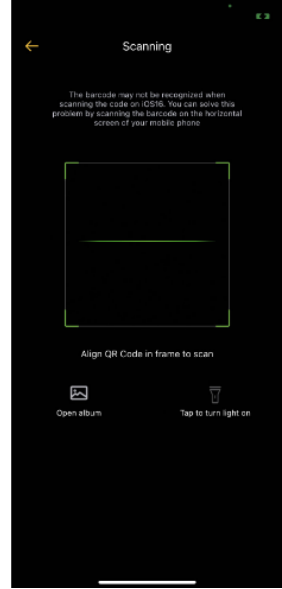
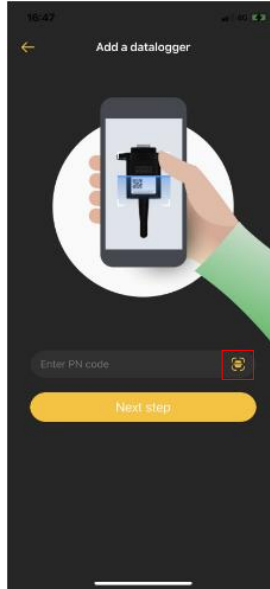
Click “device name” to access the main page of monitored device. After tapping the  icon on the top right corner, two options will pop up: edit name and delete device. When you click on the edit name, a blank input box will pop out. Then, you can edit the name for your device and tap “Confirm” to complete name modification. When you click to delete device, a dialog box will pop up asking if you really want to delete the device, and click “Delete” to complete it.



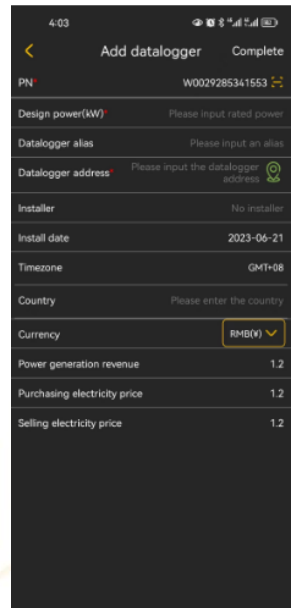
## Add device

Tap the icon  (Datalogger located on the bottom) to enter Device List page. You can review all devices here by adding or deleting Wi-Fi Module in this page.

Tap  icon on the top right corner and manually enter part number to add device. This part number label is pasted on the bottom of inverter. After entering part number, tap "Confirm" to add this device in the Device list shown as below figures.



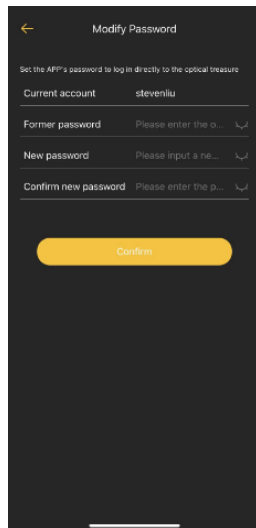
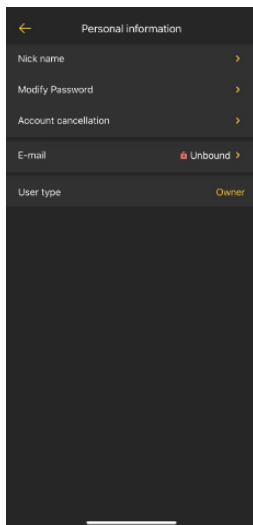
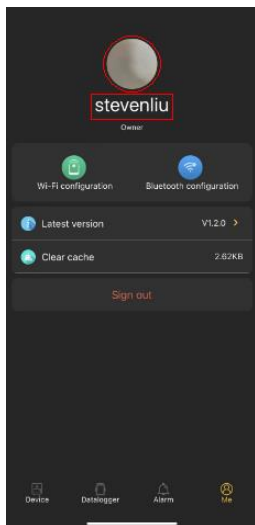
Part number label is pasted on the bottom of inverter.



**Tips:** For more information about Device List, please refer to the section 2.4.

## ME

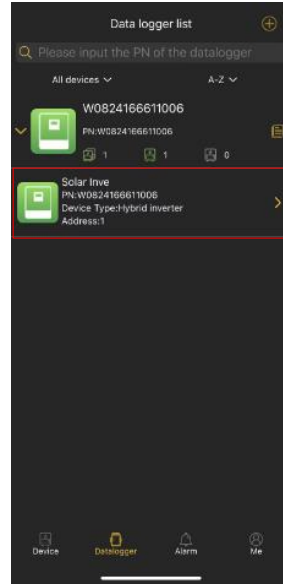
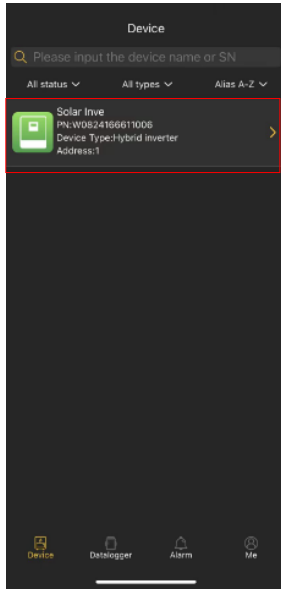
In ME page, users can modify “My information”, including 【Clear cache】 , and 【Log-out】 . You can also update and upgrade the version of the APP, and perform network settings. Click on the profile picture to replace User’s Photo, and click on the nickname to modify your “personal information”, including 【Nick name】 , 【Modify password】 , 【Account cancellation】 , 【E-mail】 , shown as below figures.



## 2-4. Device List

In Device list page, you can pull down to refresh the device information and then tap any device you want to check up for its real-time status and related information as well as to change parameter settings. Please refer to the parameter setting list.

**Note:** From both the device list and the data collector list, you can access to view device energy and related parameters



## 2-5. Device Management

### Device List

Displays all devices under the account, and displays the status and basic parameters of the devices.

Green icon indicates that the equipment is normal;

Gray icon indicates that the device is offline;

Red icon indicates equipment failure;

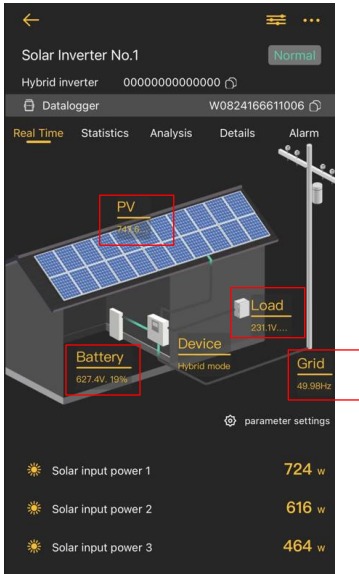
Yellow icon indicates device alerts;

Blue icon indicates the standby of the device.

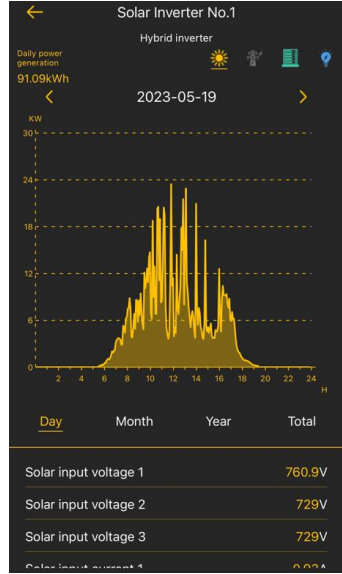
### Device Details

#### 1. Real-Time power flow

In this page, you can view dynamic power flow chart of monitored device. It contains five icons to present PV power, Device, load, Grid and battery. Click these icons to view the related parameters shown as below figures.



**Power flow**



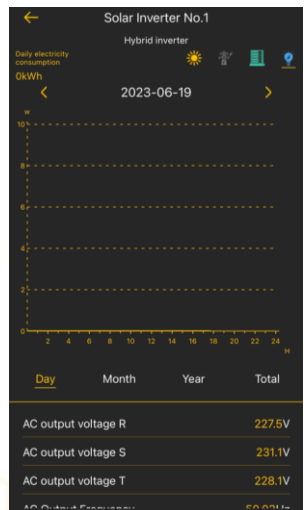
**PV screen**



**Grid screen**



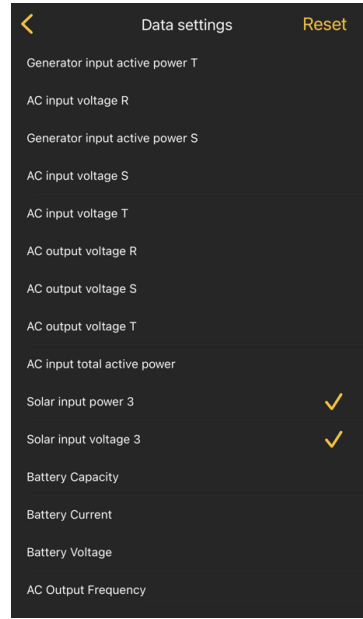
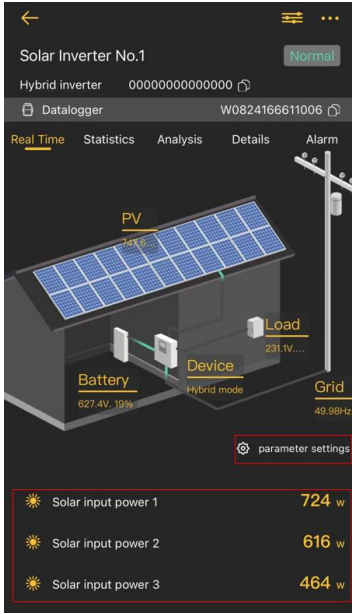
**Battery screen**



**Load screen**

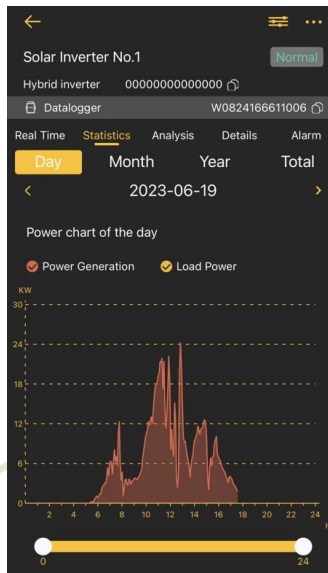
In this page, you also can modify the parameter settings according to your needs. Click the Parameter settings icon to enter the parameter setting page. After setting the parameters, the monitoring homepage will display the parameters you have set

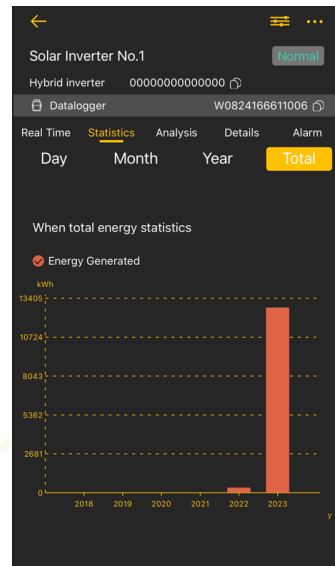
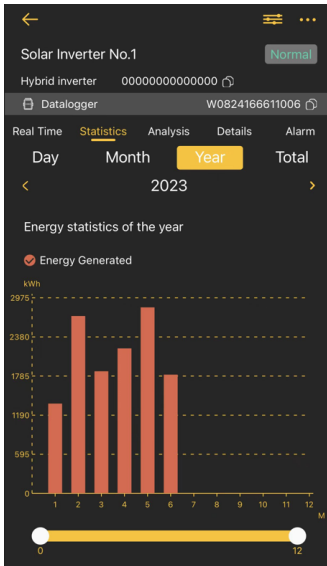
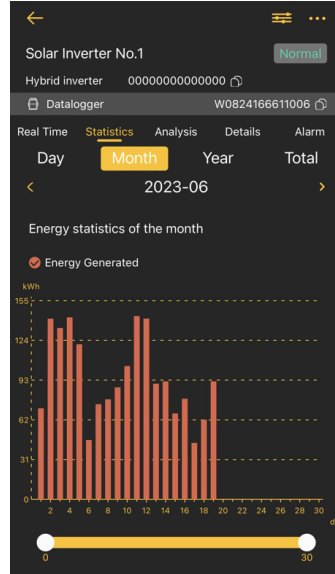
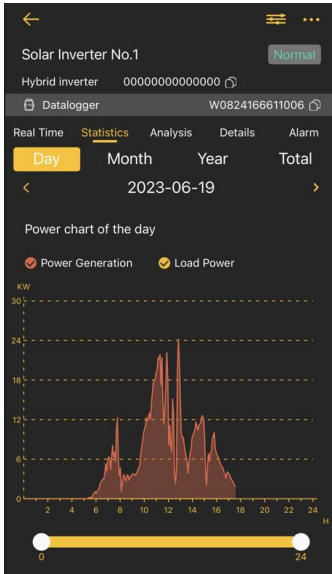




## 2. Statistics

You can view graphic chart representing the power generation, grid electricity, battery capacity, load, as well as daily, monthly, annual, and total power generation, electricity consumption, power purchase, power sale, and charging/discharging.



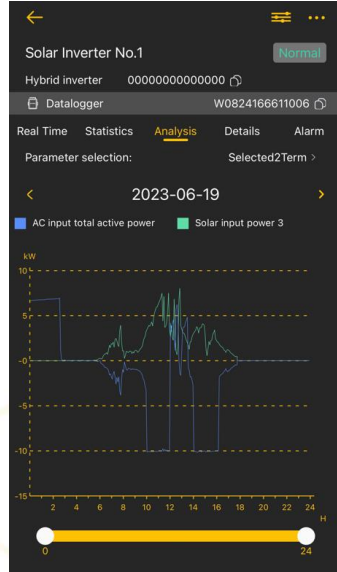
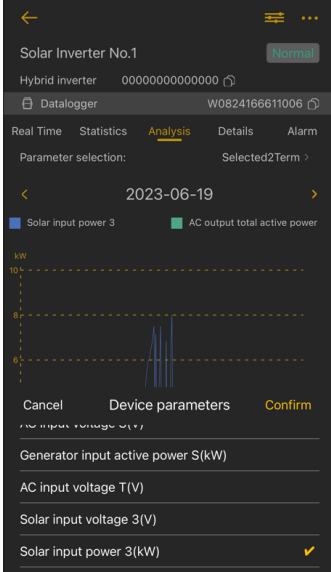
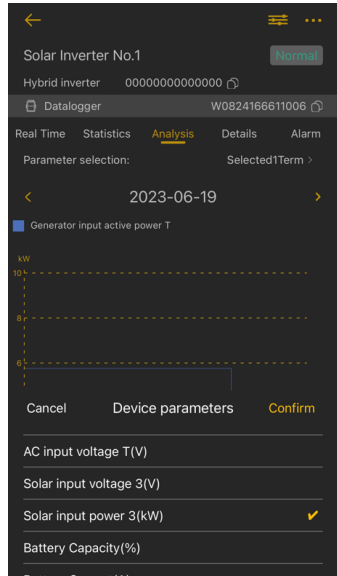
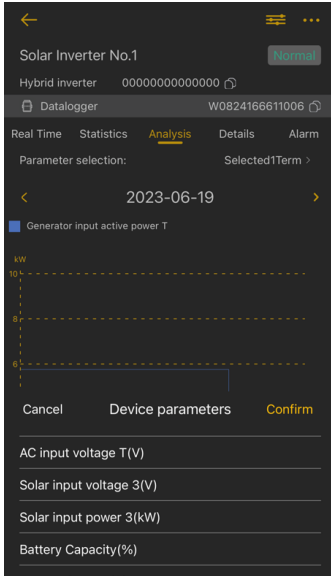


### 3. Analysis

You can select one or more parameters of the device to view the power chart for analysis and comparison.

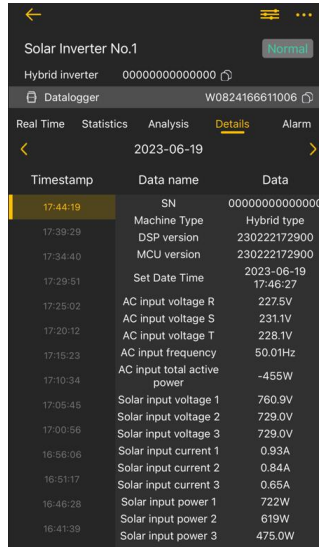
Tips: On the parameter analysis page, you can select one or more device parameters for

analysis, shown as below figures.



#### 4. Details

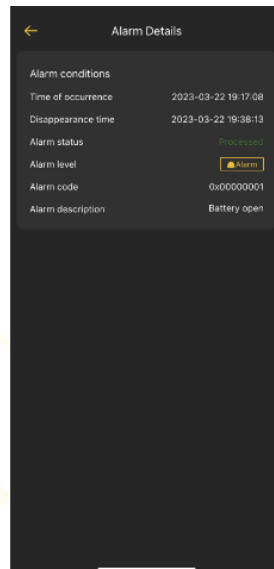
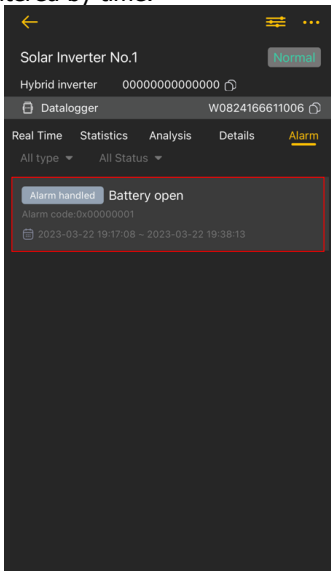
You can view the data details recorded by the device every five minutes.





Timestamp	Data name	Data
17:44:19	SN	00000000000000
	Machine Type	Hybrnd type
17:39:29	DSP version	230222172900
17:34:40	MCU version	230222172900
17:29:51	Set Date Time	2023-06-19 17:46:27
17:25:02	AC input voltage R	227.5V
17:20:12	AC input voltage S	231.1V
17:15:23	AC input voltage T	228.1V
17:10:34	AC input frequency	50.01Hz
	AC input total active power	-455W
17:05:45	Solar input voltage 1	760.9V
17:00:56	Solar input voltage 2	729.0V
	Solar input voltage 3	729.0V
16:56:06	Solar input current 1	0.93A
16:51:17	Solar input current 2	0.84A
16:46:28	Solar input current 3	0.65A
	Solar input power 1	722W
16:41:39	Solar input power 2	619W
	Solar input power 3	475.0W

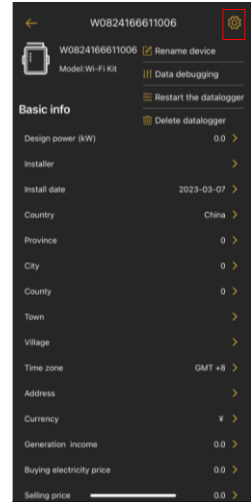
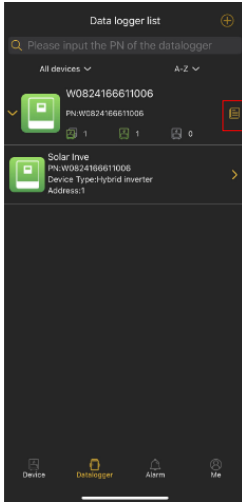
#### 5. Alarm

Tap the "Alarm" on the top to enter the device alarm page. You can view all alarms and alarm details generated by the device. Displays all alert information of an account, which can be filtered by time.



## 6. Device Information Data

Tap  on device list or click  in device homepage, you can view information about the digital collector and the digital collector connected to the device. Browse **【Basic Info】** and **【Basic parameter】** by swiping up and down. You can modify the basic information of the device on this page and restart, debug, and delete the data collector.



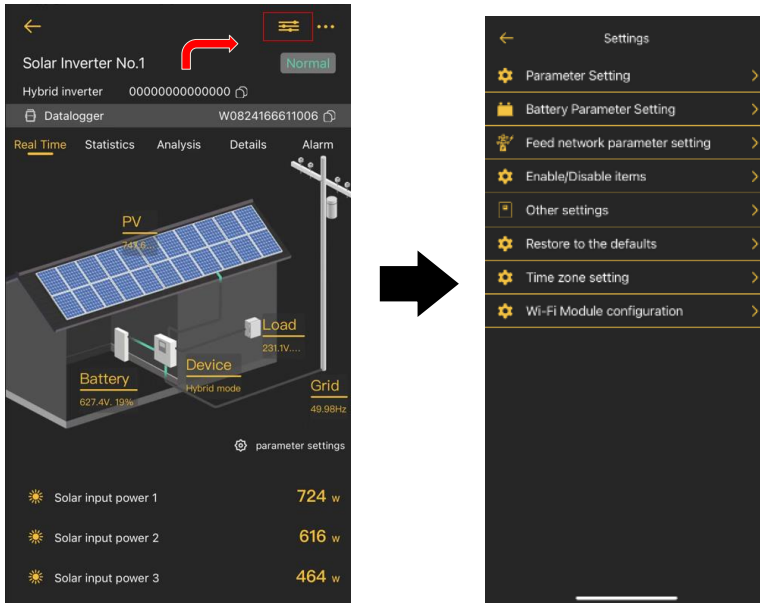
**Tips:** If you cannot view the real-time device data all the time, the possible reasons are as follows:

1. Incorrect device model selection: you can change the device model.
2. Incorrect device address: you can click to modify next to the device address to modify the device address;

**【Basic Information】** Displays basic information of the PV inverter: inverter power rating, installer information, installed date, country, installed address, time zone, currency setting, calculated generation income, buying electricity price and selling price.

**【Basic parameter】** Displays information of datalogger model, datalogger PN, datalogger status, firmware version, device quantity, online device quantity.

## 7. Parameter Setting



This page is to activate some features and set up parameters for PV inverters. Please be noted that the listing in "Parameter Setting" page in below diagram may differ from the models of monitored inverter.

There are 8 submenus: 【Output setting】, 【Battery Parameter Setting】, 【Feed network parameter setting】, 【Enable/ Disable items】, 【Other Settings】, 【Restore to the defaults】, 【Time zone setting】, 【Wi-Fi Module configuration】 to illustrate.

There are two ways to modify setting.

- Listed options to change values by tapping one of it.
- Changing values by clicking arrows or entering the numbers directly in the column.

Each function setting is saved by clicking "Issued" button.

Please refer to below parameter setting list for an overall description and be noted that the available parameters may vary depending on different models. Please always see the original product manual for detailed setting instructions.

### Parameter setting list:

Item	Description	default value
Output setting	Machine working mode setting	Query working mode
	Solar Supply Priority	Solar energy distribution of priority
		Battery>Load >Grid

Battery parameter setting	Max pv input voltage	Solar input highest voltage	1000V
	Min pv input voltage	Solar input lowest voltage	300V
	Set Solar input highest MPPT voltage	Solar input highest MPPT voltage	950V
	Set Solar input lowest MPPT voltage	Solar input lowest MPPT voltage	350V
	Maximum Charging Current	Battery maximum charge current	30A
	Max. AC Charging Current	Max. AC charging current	10A
	C.V voltage	Battery constant charge voltage(C.V.)	691.0V
	Float charge voltage	Battery float charge voltage	691.0V
	Battery Cut-off Voltage when grid is available	Battery weak voltage in hybrid mode	691.0V
	Battery Cut-off back Voltage when grid is available	Battery weak back voltage in hybrid mode	614.5V
	Battery Cut-off Voltage when grid is unavailable	Battery under voltage	580.0V
	Battery Cut-off back Voltage when grid is unavailable	Battery under back voltage	614.5V
	Max battery discharge current in hybrid mode	Battery discharge max current	50A
	LCD screen-saver start time	LCD sleep wait time	60s
	Battery under back SOC	Battery under back SOC	20%
	Battery under SOC	Battery under SOC	15%
	Battery weak back SOC in hybrid mode	Battery weak SOC in hybrid mode	20%
Battery weak SOC in hybrid mode	Battery weak back SOC in hybrid mode	80%	
Feed network Parameter Setting	Max grid-connected voltage	AC input highest voltage	264.5V
	Min grid- connected voltage	AC input lowest voltage	184.0V
	Max grid-connected	AC input highest	51.5Hz

	Frequency	frequency	
	Min grid-connected Frequency	AC input lowest frequency	47.48Hz
	Wait time before grid-connection	Wait time for feed power	60.0s
	Set feed-in reactive power	Feed-in reactive power	0.0Var
	Max Grid-connected average Voltage	AC input long-time highest average voltage	253.0V
	Max feed-in power	Max power of feeding grid	30000.0KW
	feed-in power factor	Feed-in power factor	1.0
Enable/Disable Functions	Auto-adjust PF with powers	Auto-adjust PF with power	Disable
	Auto-adjust PF when power rate reaches	Start power percentage of auto-adjusting	50%
	Min PF value when power is 100%	Minimum PF value when power percentage reach 100%	1.00
	Activate Li-Fe battery	Li-Fe battery self-test by charged at a time	Disable
	Reactive power Auto-control Enable	Reactive power Auto-control Enable	Disable
	Mute buzzer alarm	Mute buzzer beep	Disable
	Mute buzzer in the standby mode	Mute buzzer beep in standby mode	Disable
	Mute alarm in battery mode	Mute buzzer beep only on battery discharged status	Disable
	Output N-line grounding in battery mode	N/G relay close in battery mode	Disable
	Over voltage derating	De-rating power for Grid voltage	Disable
	Over frequency derating	De-rating power for Grid frequency	Disable
	Generator as AC input	Generator as AC input	Disable
Wide AC input range	Wide AC input range	Disable	



	Parallel for output	Parallel for output	Disable
	BMS Battery Connect	BMS battery connect	Disable
Other Settings	Charging source	Charging source	PV and Grid
	Remote turn on/off machine load	Remote turn on/off machine load	--
	Load supply(PV is available)	Load supply(PV is available)	Enable
	Load supply(PV is unavailable)	Load supply(PV is unavailable)	Enable
	Allow to feed-in to the Grid	Allow to feed-in to the Grid	Enable
	Allow battery to be connected to the grid when PV is available	Allow battery to be connected to the grid when PV is available	Disable
	Allow battery to be connected to the grid when PV is unavailable	Allow battery to be connected to the grid when PV is unavailable	Disable
	Start Time For Enable AC Charge Working	Start Time For Enable AC Charge Working	00:00
	Ending Time For Enable AC Charge Working	Ending Time For Enable AC Charge Working	00:00
	Start Time For Enable AC Charge Working 2	Start Time For Enable AC Charge Working 2	00:00
	Ending Time For Enable AC Charge Working 2	Ending Time For Enable AC Charge Working 2	00:00
	Start Time For Enable AC supply the load	Start Time For Enable AC supply the load	00:00
	Ending Time For Enable AC supply the load	Ending Time For Enable AC supply the load	00:00
Set Date Time		00:00	
Restore to the default	This function is to restore all settings back to default settings.		--
Time zone setting	This function is used to modify the time zone		--
Wi-Fi Module configuration	This function is used to reconfigure the network or change the connection router.		--