

# MOTOMA<sup>®</sup>

Power into the Future

## USER MANUAL



### InfiniSolar WP TWIN HMI SOLAR INVERTER / CHARGER

# Table Of Contents

1.	Introduction.....	1
2.	Important Safety Warning.....	2
3.	Unpacking & Overview .....	4
	3-1. Packing List.....	4
	3-2. Product Overview .....	4
4.	Installation .....	5
	4-1. Precaution .....	5
	4-2. Selecting Mounting Location.....	5
	4-3. Mounting Unit .....	5
5.	Grid (Utility) Connection .....	6
	5-1. Preparation .....	6
	5-2. Connecting to the AC Utility .....	7
6.	PV Module (DC) Connection.....	10
7.	Battery Connection.....	14
8.	Load (AC Output) Connection .....	15
	8-1. Preparation .....	15
	8-2. Connecting to the AC output .....	15
9.	Communication Connection .....	17
10.	Dry Contact Signal .....	18
	10-1. Electric Parameter .....	18
	10-2. Function Description .....	18
11.	Application with Energy Meter.....	20
12.	Commissioning.....	21
13.	Initial Setup.....	22
14.	Operation .....	34
	14-1. LCD Display Icons.....	34
15.	Charging Management .....	50
16.	Maintenance & Cleaning .....	52
17.	Trouble Shooting.....	53
	17-1. Warning List.....	53
	17-2. Fault Reference Codes .....	54
18.	Specifications.....	57
	Appendix I: Parallel Installation Guide .....	59
	Appendix II: BMS .....	68
	Appendix III: The Wi-Fi Operation Guide .....	70

# 1. Introduction

This hybrid PV inverter can provide power to connected loads by utilizing PV power, utility power and battery power.

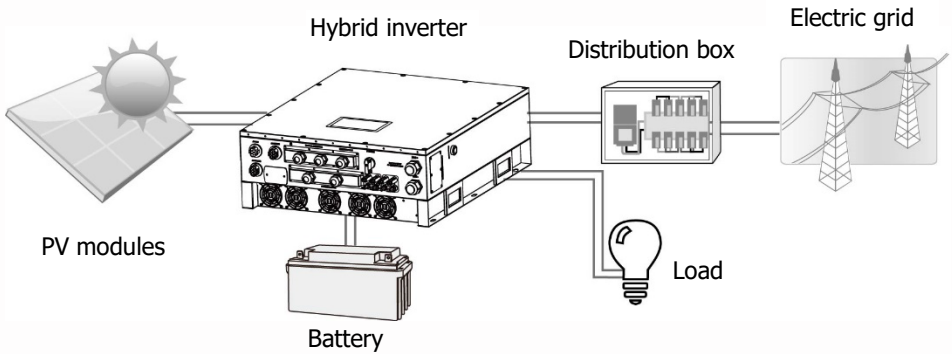

**Figure 1 Basic hybrid PV System Overview**

Depending on different power situations, this hybrid inverter is designed to generate continuous power from PV solar modules (solar panels), battery, and the utility. When MPP input voltage of PV modules is within acceptable range (see specification for the details), this inverter is able to generate power to feed the grid (utility) and charge battery. This inverter is only compatible with PV module types of single crystalline and poly crystalline. Do not connect any PV array types other than these two types of PV modules to the inverter. Do not connect the positive or negative terminal of the solar panel to the ground. See Figure 1 for a simple diagram of a typical solar system with this hybrid inverter.

**Note:** By following the EEG standard, Solar Inverters sold in German territory are not allowed to charge battery from Utility. The relevant function is automatically disabled by the software.

## 2. Important Safety Warning

**Before using the inverter, please read all instructions and cautionary markings on the unit and this manual. Store the manual where it can be accessed easily.**

This manual is for qualified personnel. The tasks described in this manual may be performed by qualified personnel only.

### General Precaution-

#### Conventions used:

**WARNING!** Warnings identify conditions or practices that could result in personal injury;

**CAUTION!** Caution identify conditions or practices that could result in damaged to the unit or other equipment connected.



**WARNING!** Before installing and using this inverter, read all instructions and cautionary markings on the inverter and all appropriate sections of this guide.



**WARNING!** Normally grounded conductors may be ungrounded and energized when a ground fault is indicated.



**WARNING!** This inverter is heavy. It should be lifted by at least two persons.



**CAUTION!** Authorized service personnel should reduce the risk of electrical shock by disconnecting AC, DC and battery power from the inverter before attempting any maintenance or cleaning or working on any circuits connected to the inverter. Turning off controls will not reduce this risk. Internal capacitors can remain charged for 5 minutes after disconnecting all sources of power.



**CAUTION!** Do not disassemble this inverter yourself. It contains no user-serviceable parts. Attempt to service this inverter yourself may cause a risk of electrical shock or fire and will void the warranty from the manufacturer.



**CAUTION!** To avoid a risk of fire and electric shock, make sure that existing wiring is in good condition and that the wire is not undersized. Do not operate the Inverter with damaged or substandard wiring.





**CAUTION!** Under high temperature environment, the cover of this inverter could be hot enough to cause skin burns if accidentally touched. Ensure that this inverter is away from normal traffic areas.



**CAUTION!** Use only recommended accessories from installer. Otherwise, not-qualified tools may cause a risk of fire, electric shock, or injury to persons.



**CAUTION!** To reduce risk of fire hazard, do not cover or obstruct the cooling fan.



**CAUTION!** Do not operate the Inverter if it has received a sharp blow, been dropped, or otherwise damaged in any way. If the Inverter is damaged, please call for an RMA (Return Material Authorization).



**CAUTION!** AC breaker, DC switch and Battery circuit breaker are used as disconnect devices and these disconnect devices shall be easily accessible.

**Before working on this circuit**

- Isolate inverter/Uninterruptible Power System (UPS)
- Then check for Hazardous Voltage between all terminals including the protective earth.



**Risk of Voltage Backfeed**

**Symbols used in Equipment Markings**

	Refer to the operating instructions
	Caution! Risk of danger
	Caution! Risk of electric shock
	Caution! Risk of electric shock. Energy storage timed discharge for 5 minutes.
	Caution! Hot surface

### 3. Unpacking & Overview

#### 3-1. Packing List

Before installation, please inspect the unit. Be sure that nothing inside the package is damaged. You should have received the following items inside of package:

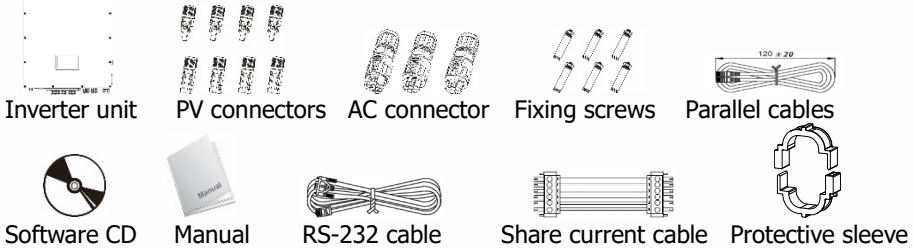

#### 3-2. Product Overview

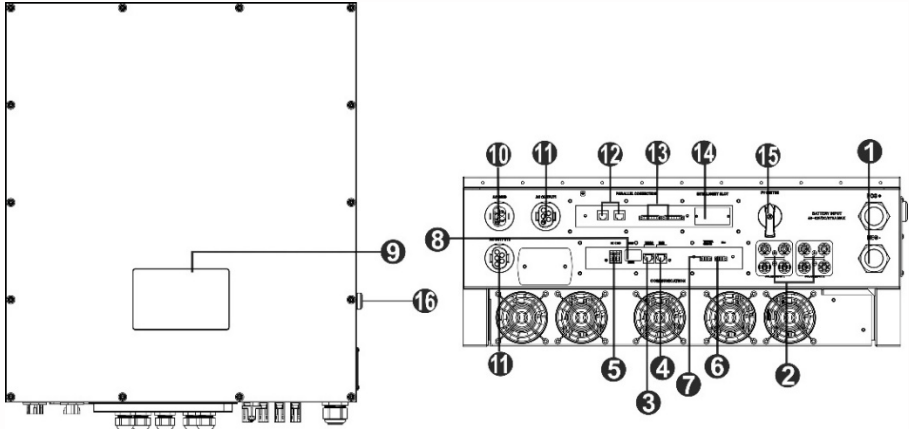

- |   |  |
|---|--|
| 1) Battery connectors   | 10) AC Grid connectors                     |
| 2) PV connectors  | 11) AC output connectors (Load connection) |
| 3) RS-232 communication port  | 12) Parallel communication port            |
| 4) BMS  | 13) Current sharing port                   |
| 5) Dry contact  | 14) Intelligent slot                       |
| 6) EPO  | 15) DC switch                              |
| 7) Battery thermal sensor   | 16) Cold start button                      |
| 8) USB communication port   |  |
| 9) LCD display panel (Please check section 14 for detailed LCD operation) |  |

## 4. Installation

### 4-1. Precaution

This Hybrid inverter is designed for indoor or outdoor use (IP65), please make sure the installation site meets below conditions:

- Not in direct sunlight
- Not in areas where highly flammable materials are stored.
- Not in potential explosive areas.
- Not in the cool air directly.
- Not near the television Antenna or antenna cable.
- Not higher than altitude of about 2000 meters above sea level.
- Not in environment of precipitation or humidity (>95%)

Please AVOID direct sunlight, rain exposure, snow laying up during installation and operation.

### 4-2. Selecting Mounting Location

- Please select a vertical wall with load-bearing capacity for installation, appropriate for installation on concrete or other non-flammable surfaces.
- The ambient temperature should be between -25~60°C to ensure optimal operation.
- Be sure to keep other objects and surfaces as shown in the diagram to guarantee sufficient heat dissipation and have enough space for removing wires.
- For proper air ventilation to dissipate heat, allow a clearance of approx. 50cm to the side and approx. 50cm above and below the unit. And 100cm toward the front.

### 4-3. Mounting Unit

**WARNING!!** Remember that this inverter is heavy! Please be carefully when lifting out from the package.

The wall should be installed with the proper screws. After that, the device should be bolted on securely.

**WARNING!!** FIRE HAZARD.  
SUITABLE FOR MOUNTING ON CONCRETE OR OTHER NON-COMBUSTIBLE SURFACE ONLY.

1. Drill six holes in the marked locations with supplied six screws. The reference tightening torque is 35 N.m.
2. Fix the inverter on the wall.

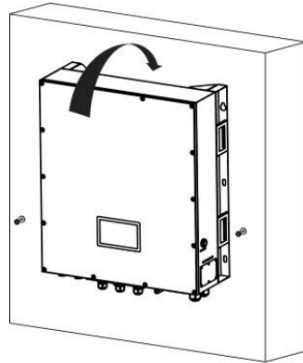
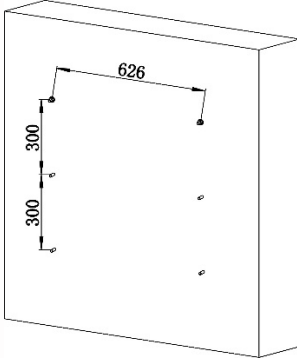

3. Check if the inverter is firmly secured.

## 5. Grid (Utility) Connection

### 5-1. Preparation

**NOTE:** The AC input overvoltage is of category III. It should be connected to the power distribution.

**NOTE2:** Before connecting to grid, please install a separate AC breaker between inverter and grid. The recommended AC breaker is 40A.

**WARNING!** It's very important for system safety and efficient operation to use appropriate cable for grid (utility) connection. To reduce risk of injury, please use the proper recommended cable size as below.

Suggested cable requirement for AC wire:

Nominal Grid Voltage	230VAC per phase
Conductor cross-section (mm <sup>2</sup> )	10-16
AWG no.	8-6

## 5-2. Connecting to the AC Utility

### Overview of AC Connection Socket



Component	Description
A	Pressure dome
B	Plastic ring
C	Protective element
D	Socket element

Step 1: Check the grid voltage and frequency with an AC voltmeter. It should be the same to "VAC" value on the product label.

Step 2: Turn off the circuit breaker.

Step 3: Remove 13mm section of insulation sleeve for five conductors.

Step 4: Thread the five cables through pressure dome (A), plastic ring (B) and protective element (C) in sequence.

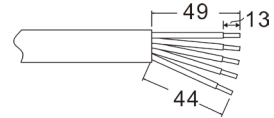

Step 5: Thread five cables through socket element (D) according to polarities indicated on it and tighten the screws to fix wires after connection.

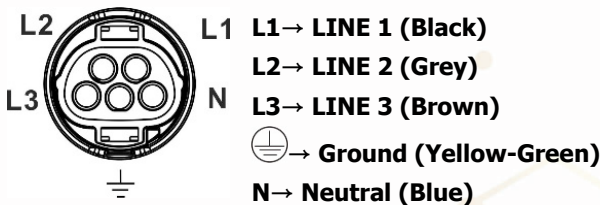

The reference tightening torque is 1.5-2.5 N.m.

Step 6: Push protective element (C) on to socket element (D) until both are locked tightly. Then, twist protective element (C) and pressure dome (A) so that all cables are firmly connected.

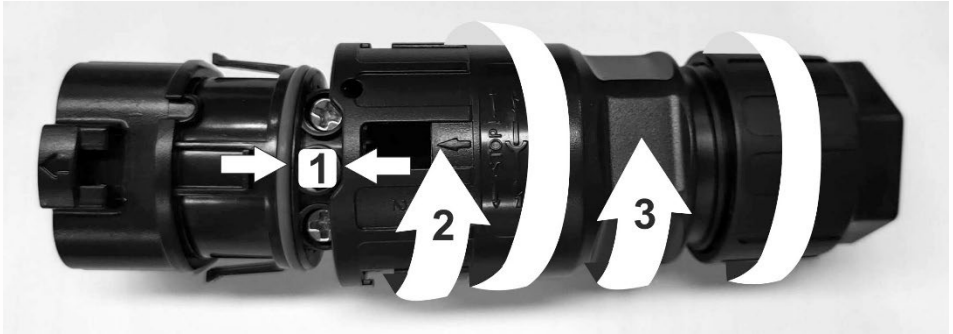

Step 7: Plug the AC connection socket into AC grid terminal of the inverter.

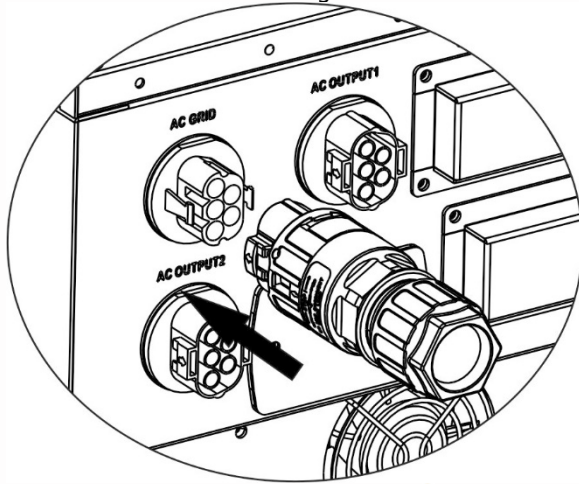

**CAUTION:** To prevent risk of electric shock, ensure the ground wire is properly earthed before operating this hybrid inverter no matter the grid is connected or not.

Step 8: After plugging the connector, press two ends of protective sleeve to lock tightly.

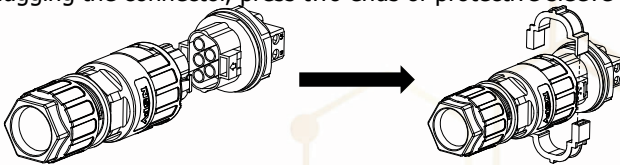

**NOTE:** Follow the chart to unlock the protective sleeve.

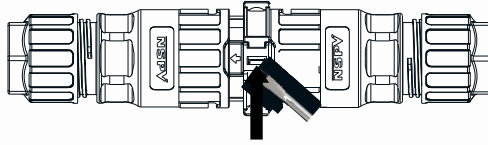

Press here to unlock with a flathead screwdriver

**ATTENTION:** This AC connector protective sleeve is used for anti-electric shock protection at the Connector port. It is required to connect the plug and protective sleeve no matter if the load is connected or not.

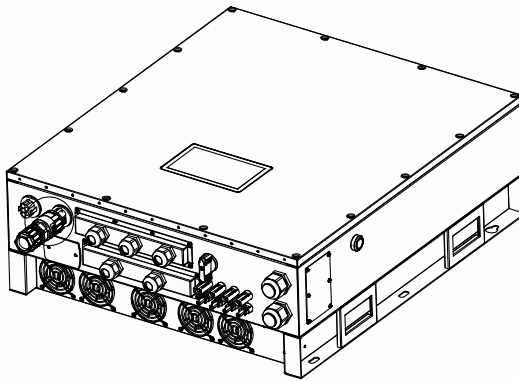

**With load connected**

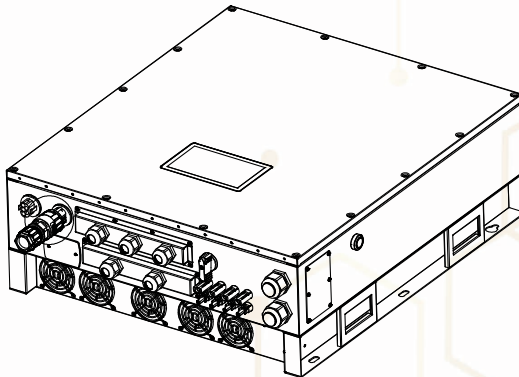

**Without load connected**

## 6. PV Module (DC) Connection

**NOTE1:** Please use 1000VDC/20A circuit breaker.

**NOTE2:** The PV input overvoltage is of category II.

Please follow below steps to connect PV module:

**WARNING:** Because this inverter is non-isolated, only two types of PV modules are acceptable: single crystalline and poly crystalline with class A-rated. To avoid any malfunction, do not connect any PV modules with possibility of leakage current to the inverter. For example, grounded PV modules will cause leakage current to the inverter.

**CAUTION:** It's requested to have PV junction box with surge protection. Otherwise, it will cause inverter damage when lightning occurs on PV modules.

Step 1: Check the input voltage of PV array modules. The acceptable input voltage of the inverter is 350VDC - 1000VDC. This system is only applied with two strings of PV array. Please make sure that the maximum current load of each PV input connector is 23A.

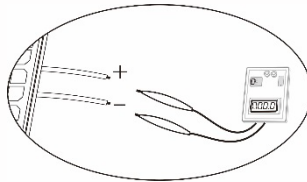





**CAUTION:** Exceeding the maximum input voltage can destroy the unit!! Check the system before wire connection.

Step 2: Disconnect the circuit breaker and switch off the DC switch.

Step 3: Assemble the provided PV connectors with PV modules by the following below steps.

### **Components for PV connectors and Tools:**

Female connector housing	
Female terminal	
Male connector housing	
Male terminal	



Crimping tool and spanner



**Cable preparation and connector assembly process:**

Strip one cable 8 mm on both end sides and be careful NOT to nick the conductors.

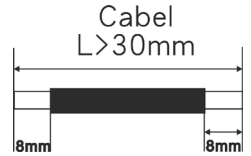

Insert striped cable into female terminal and crimp female terminal as shown below.



Insert assembled cable into female connector housing as shown below.

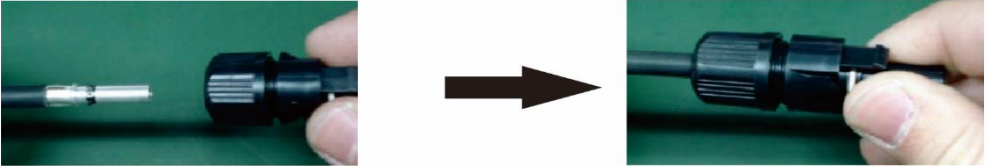

Insert striped cable into male terminal and crimp male terminal as shown below.



Insert assembled cable into male connector housing as shown below.

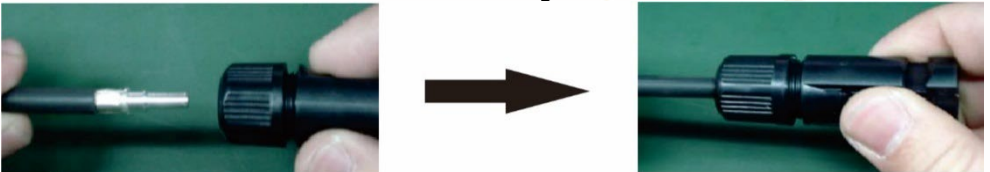

Then, use spanner to screw pressure dome tightly to female connector and male connector as shown below.



Step 4: Check correct polarity of connection cable from PV modules and PV input connectors. Then, connect positive pole (+) of connection cable to positive pole (+) of PV input connector. Connect negative pole (-) of connection cable to negative pole (-) of PV input connector.

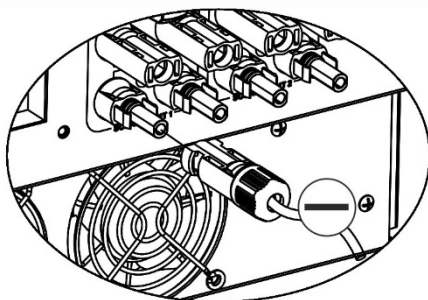
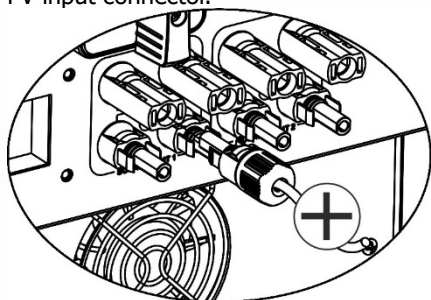

**WARNING!** It's very important for system safety and efficient operation to use appropriate cable for PV module connection. To reduce risk of injury, please use the proper recommended cable size as below.

Conductor cross-section (mm <sup>2</sup> )	AWG no.
6	10

**CAUTION: Never** directly touch terminals of the inverter. It will cause lethal electric shock.

**CAUTION:** Do NOT touch the inverter to avoid electric shock. When PV modules are exposed to sunlight, it may generate DC voltage to the inverter.

## Recommended Panel Configuration

	Solar panel			
Nominal Max. Power (Pmax) (W)	430	455	520	535
Opt. Operating Voltage (Vmp) (V)	40.3	41.3	41.6	41.9
Opt. Operating Current (Imp) (A)	10.68	11.02	12.5	12.77
Open Circuit Voltage (Voc) (V)	48.3	49.3	49.14	49.44
Short Circuit Current (Isc) (A)	11.37	11.66	13.23	13.5
For 16KW input recommendation				
<b>Numbers in series of MPPT1</b>	19	18	16	15
<b>Numbers of strings in MPPT1</b>	1	1	1	1
Maximum input voltage of MPPT1 (V)	917.7	887.4	786.24	741.6
Input power of MPPT1 (W)	8170	8190	8320	8025
<b>Numbers in series of MPPT2</b>	19	18	16	15
<b>Numbers of strings in MPPT2</b>	1	1	1	1
Maximum input voltage of MPPT1 (V)	917.7	887.4	786.24	741.6
Input power of MPPT2 (W)	8170	8190	8320	8025
Total input power (W)	16340	16380	16640	16050
Minimum input recommendation				
<b>Numbers in series- MPPT1</b>	10	10	10	10
<b>Numbers of strings in MPPT1</b>	1	1	1	1
Maximum input voltage MPPT1 (V)	483	493	491.4	494.4
Input power MPPT1 (W)	4300	4550	5200	5350
<b>MPPT2 Numbers in series</b>	10	10	10	10
<b>MPPT2 Numbers of strings</b>	1	1	1	1
MPPT1Maximum input voltage (V)	483	493	491.4	494.4
Input power of MPPT2 (W)	4300	4550	5200	5350

## 7. Battery Connection

**CAUTION:** Before connecting to batteries, please install **separately** a DC circuit breaker between inverter and batteries.

**NOTE1:** Please only use sealed lead acid battery, vented and Gel battery. Please check maximum charging voltage and current when first using this inverter. If using Lithium iron or Nicd battery, please consult with installer for the details.

**NOTE2:** Please use 60VDC/300A circuit breaker.

**NOTE3:** The overvoltage category of the battery input is II.

Please follow below steps to implement battery connection:

Step 1: Check the nominal voltage of batteries. The nominal input voltage for inverter is 48VDC.

Step 2: Use two battery cables. Remove insulation sleeve 12 mm and insert conductor into cable ring terminal. Refer to right chart.

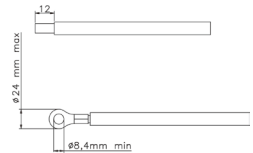

Step 3: Remove battery cover and follow battery polarity guide printed near the battery terminal! Place the external battery cable ring terminal over the battery terminal.

**RED cable to the positive terminal (+);**

**BLACK cable to the negative terminal (-).**

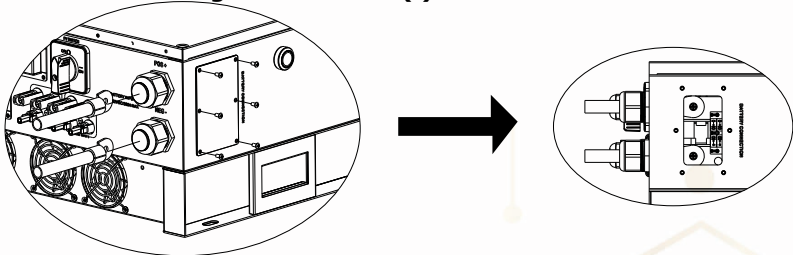

**WARNING!** Wrong connections will damage the unit permanently.

Step 4: Make sure the wires are securely connected. The reference tightening torque is 5.5~7.0 N.m.

**WARNING!** It's very important for system safety and efficient operation to use appropriate cable for battery connection. To reduce risk of injury, please use the proper recommended cable size as below.

Model	Nominal Battery Voltage	Conductor cross-section (mm <sup>2</sup> )	AWG no.	Protective earthing (battery side)
12 KW	48V	107	4/0	150mm <sup>2</sup> (300kcmil)
15 KW	48V	151	300	150mm <sup>2</sup> (300kcmil)

## 8. Load (AC Output) Connection

### 8-1. Preparation

**CAUTION:** To prevent further supply to the load via the inverter during any mode of operation, an additional disconnection device should be placed on in the building wiring installation.

**WARNING!** It's very important for system safety and efficient operation to use appropriate cable for AC connection. To reduce risk of injury, please use the proper recommended cable size as below.

Nominal Grid Voltage	208/220/230/240 VAC per phase
Conductor cross-section (mm <sup>2</sup> )	5.5-10
AWG no.	10-8

### 8-2. Connecting to the AC output

Overview of Load Connection Socket



Component	Description
A	Pressure dome
B	Plastic ring
C	Protective element
D	Socket element

There are two output connectors: AC output 1 and AC output 2. Please follow the same procedures to install AC output 1 and AC output 2.

Step 1: Remove 8.5 mm section of the insulation sleeve for five conductors.

Step 2: Thread the five cables through pressure dome (A), plastic ring (B) and protective element (C) in sequence.

Step 3: Thread five cables through socket element (D) according to polarities indicated on it and tighten the screws to fix wires after connection.

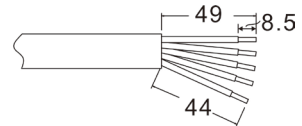



The reference tightening torque is 1.0-1.5 N.m.

Step 4: Push protective element (C) on to socket element (D) until both are locked tightly. Then, twist protective element (C) and pressure dome (A) so that all cables are firmly connected.

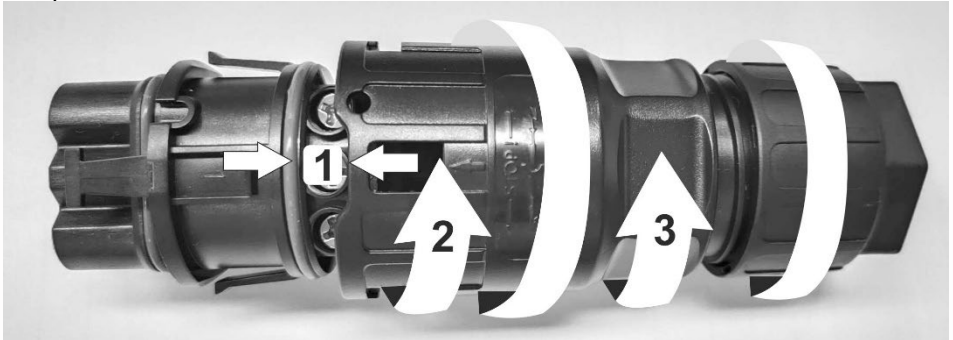

Step 5: Plug the socket into the terminal.

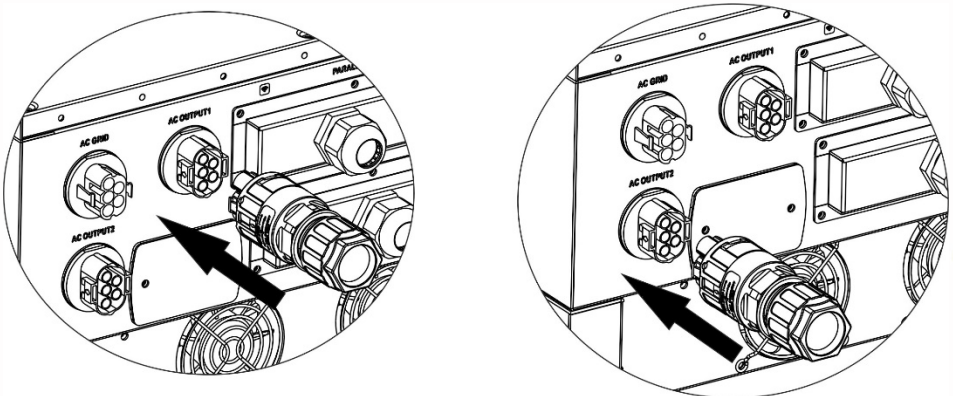

## AC OUTPUT 1

## AC OUTPUT 2

**CAUTION:** It's only allowed to connect load to "AC Output Connector". Do NOT connect the utility to "AC Output Connector".

**CAUTION:** Be sure to connect L terminal of load to L terminal of "AC Output Connector" and N terminal of load to N terminal of "AC Output Connector". The G terminal of "AC Output Connector" is connected to grounding of the load. Do NOT mis-connect.

## 9. Communication Connection

### Serial Connection

The inverter is equipped with several communication ports and it is also equipped with a slot for alternative communication interfaces in order to communicate with a PC with corresponding software. This intelligent slot is suitable to install with SNMP card and Modbus card. Follow below procedure to connect communication wiring and install the software.

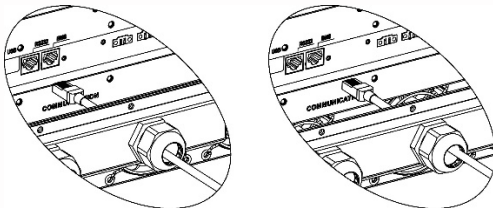
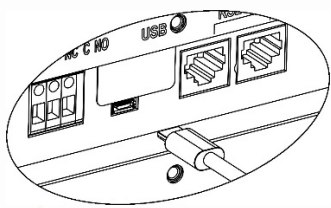
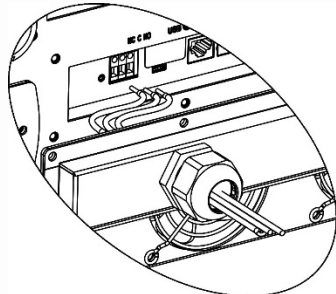
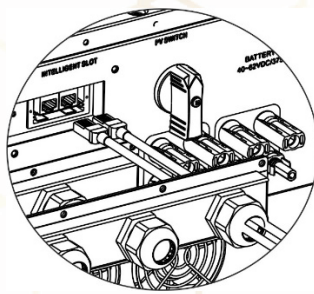
<p>For RS232 or BMS port, use a RJ45 cable as follows:</p>	<p>For USB port, use a USB cable as follows:</p>
	
<p>For Dry contact port, please remove insulation sleeve 8 mm for three conductors and insert three cables into ports</p>	<p>For SNMP or MODBUS port, use the RJ45 cables as follows:</p>
	



Please install monitoring software in your computer. Detailed information is listed in the chapter 12. After software is installed, you may initial the monitoring software and extract data through communication port.

### Wi-Fi Connection

This unit is equipped with a Wi-Fi transmitter. Wi-Fi transmitter can enable wireless communication between off-grid inverters and monitoring platform. Users can access and control the monitored inverter with downloaded APP. You may find "i.Solar" app from the Apple® Store and Google® Play Store. All data loggers and parameters are saved in iCloud. For quick installation and operation, please refer to Appendix II - The Wi-Fi Operation Guide for details.

## 10. Dry Contact Signal

There is one dry contact available on the bottom panel. It could be used to remote control for external generator.

### 10-1. Electric Parameter

Parameter	Symbol	Max.	Unit
Relay DC voltage	Vdc	30	V
Relay DC current	Idc	1	A

Note: The application of the dry contact should not exceed the electric parameter shown as above. Otherwise, the internal relay will be damaged.

### 10-2. Function Description

Unit Status	Condition	Dry contact port: 	
		NO&C	NC&C
Power Off	Unit is off and no output is powered.	Open	Close
Power On	Battery voltage is lower than setting battery cut-off discharging voltage when grid is available.	Close	Open
	Battery voltage is lower than setting battery cut-off discharging voltage when grid is unavailable.	Close	Open
	Battery voltage is higher than below 2 setting values: 1. Battery re-discharging voltage when grid is available. 2. Battery re-discharging voltage	Open	Close



when grid unavailable.

You can set the related parameters in software. Refer to below chart:

**Parameters setting**

Min. grid-connected voltage: 184 V	Apply	The waiting time before grid-connection: 60 Sec.	Apply
Max. grid-connected voltage: 284.5 V	Apply	Max. grid-connected average voltage: 253 V	Apply
Min. grid-connected frequency: 47.48 Hz	Apply	Max. feed-in grid power: 10,000 W	Apply
Max. grid-connected frequency: 51.9 Hz	Apply		
Min. PV input voltage: 300 V	Apply	Floating charging voltage: 5.4 V	Apply
Max. PV input voltage: 900 V	Apply	Battery cut-off discharging voltage when Grid is available: 4.8 V	Apply
Min. MPP voltage: 350 V	Apply	Battery re-discharging voltage when Grid is available: 5.4 V	Apply
Max. MPP voltage: 850 V	Apply	Battery cut-off discharging voltage when Grid is unavailable: 4.2 V	Apply
Max. charging current: 60 A	Apply	Battery re-discharging voltage when Grid is unavailable: 4.8 V	Apply
Max. AC charging current: 60 A	Apply	Battery temperature compensation: 0 mV	Apply
Bulk charging voltage(C.V. voltage): 56 V	Apply	Feeding grid power calibration: 0 W	Apply
Start LCD screen-saver after: None Sec.	Apply	Max. battery discharge current in hybrid mode: 10 A	Apply
Mute Buzzer alarm: <input type="radio"/> Enable <input checked="" type="radio"/> Disable	Apply	Generator as AC source: <input type="radio"/> Enable <input checked="" type="radio"/> Disable	Apply
Mute the buzzer in the Standby mode: <input type="radio"/> Enable <input checked="" type="radio"/> Disable	Apply	Activate Li-Fe battery while commissioning: <input type="radio"/> Yes <input checked="" type="radio"/> No	Apply
Mute alarm in battery mode: <input type="radio"/> Enable <input checked="" type="radio"/> Disable	Apply	Wide AC input range: <input type="radio"/> Enable <input checked="" type="radio"/> Disable	Apply

When float charging current is less than X (A) and continued T (Min),then charger off,when battery voltage is less than Y (V),then charger on again.

X: 0 A T: 60 Min Y: 53 V Apply

Any schedule change will affect the power generated and shall be conservatively made.

System time: 2014-10-27  
14:03:21 Apply

Close

## 11. Application with Energy Meter

With Modbus card II and energy meter, hybrid inverter can be easily integrated into the existing household system. For details please refer to Modbus card II manual.

**Note:** this application is only valid for **Grid-Tie with Backup II** mode.

Equipped with Modbus card II, hybrid inverter is connected to energy meter with RS485 communication port. It's to arrange self-consumption via Modbus card to control power generation and battery charging of the inverter.

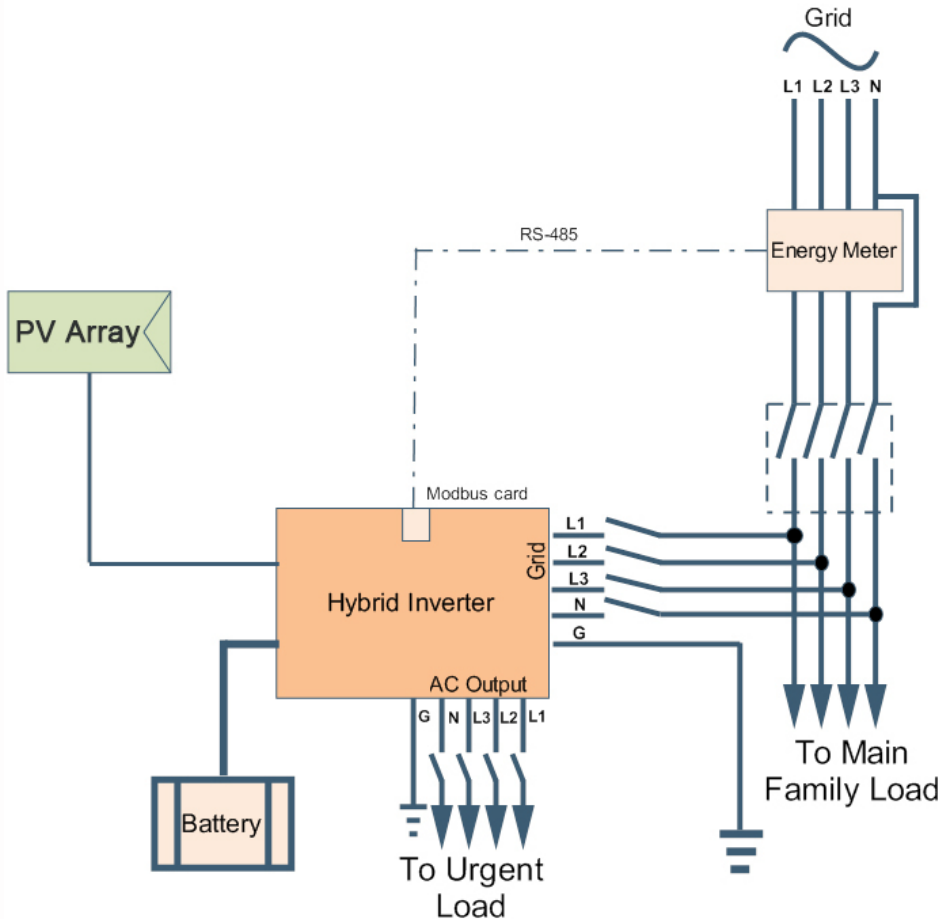

## 12. Commissioning

Step 1: Check the following requirements before commissioning:

- Ensure the inverter is firmly secured
- Check if the open circuit DC voltage of PV module meets requirement (Refer to Section 6)
- Check if the open circuit utility voltage of the utility is at approximately same to the nominal expected value from local utility company.
- Check if connection of AC cable to grid (utility) is correct if the utility is required.
- Full connection to PV modules.
- AC circuit breaker (only applied when the utility is required), battery circuit breaker, and DC circuit breaker are installed correctly.

Step 2: Switch on the battery circuit breaker and then switch on PV DC breaker. After that, if there is utility connection, please switch on the AC circuit breaker. At this moment, the inverter is turned on already. However, there is no output generation for loads. Then:

- If LCD lights up to display the current inverter status, commissioning has been successfully. After pressing "Inverter" icon in main page for 3 seconds to enter system on/off page. After pressing "On" button, this inverter will start to supply power to the loads.
- If a warning/fault indicator appears in LCD, an error has occurred to this inverter. Please inform your installer.

**NOTE:** If only battery is available and LCD is off, press "Cold start button" to light up the LCD display.

Step 3: Please insert CD into your computer and install monitoring software in your PC. Follow below steps to install software.

1. Follow the on-screen instructions to install the software.
2. When your computer restarts, the monitoring software will appear as shortcut icon located in the system tray, near the clock.

**NOTE:** If using modbus card as communication interface, please install bundled software. Check local dealer for the details.

## 13. Initial Setup

Before inverter operation, it's required to set up "Operation Mode" via software. Please strictly follow below steps to set up. For more details, please check software manual.

**Step 1:** After turning on the inverter and installing the software, please click "Open Monitor" to enter main screen of this software.

**Step 2:** Log in into software first by entering default password "administrator".

**Step 3:** Select Device Control>>MyPower Management. It is to set up inverter operation mode and personalized interface. Refer to diagram below.

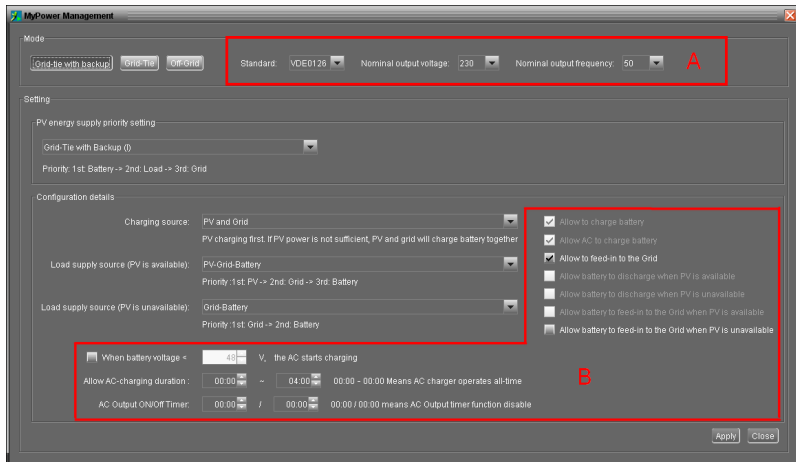
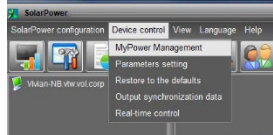

### Mode

There are three operation modes: Grid-tie with backup, Grid-Tie and Off-Grid.

- Grid-tie with backup: PV power can feed-in back to grid, provide power to the load and charge battery. There are four options available in this mode: Grid-tie with backup I, II, III and IV. In this mode, users can configure PV power supply priority, charging source priority and load supply source priority. However, when Grid-tie with backup IV option is selected in PV energy supply priority, the inverter is only operated between two working logics based on defined peak time and off-peak time of electricity. Only peak time and off-peak time of electricity are able to set up for optimized electricity usage.
- Grid-Tie: PV power only can feed-in back to grid.
- Off-Grid: PV power only provides power to the load and charge battery. No feed-in back to grid is allowed.

## SECTION A:

**Standard:** It will list local grid standard. It's requested to have factory password to make any modifications. Please check local dealer only when this standard change is requested.

**CAUTION:** Wrong setting could cause the unit damage or not working.

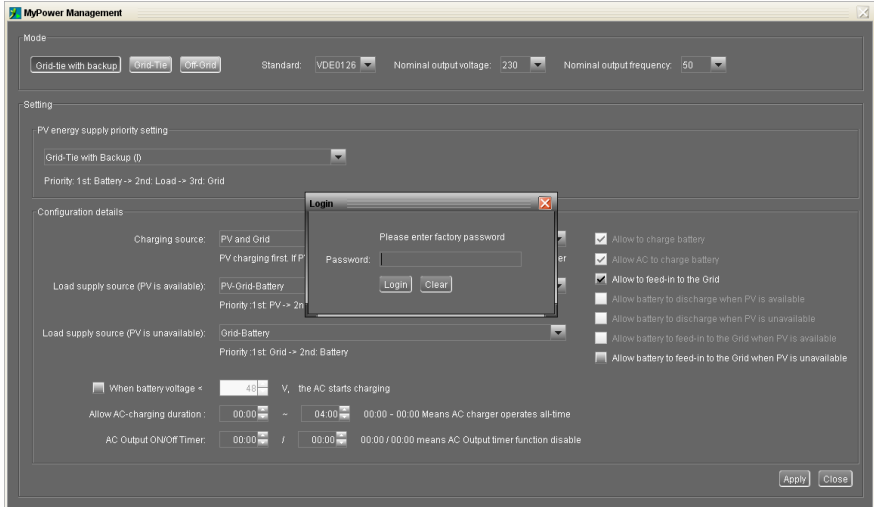

Nominal Output Voltage: 230V.

Nominal Output Frequency: 50HZ.

## SECTION B:

This section contents may be different based on different selected types of operations.

**Allow AC charging duration:** It's a period time to allow AC (grid) to charge battery. When the duration is set up as 0:00-00:00, it means no time limitation for AC to charge battery.

**AC output ON/Off Timer:** Set up on/off time for AC output of inverter. If setting it as 00:00/00:00, this function is disabled.

**Allow to charge battery:** This option is automatically determined by setting in "Charging source". It's not allowed to modify here. When "NONE" is selected in charging source section, this option becomes unchecked as grey text.

**Allow AC to charge battery:** This option is automatically determined by setting in "Charging source". It's not allowed to modify here. When "Grid and PV" or "Grid or PV" is selected in charging source section, this option is default selected. Under

Grid-tie mode, this option is invalid.

Allow to feed-in to the Grid: This option is only valid under Grid-tie and Grid-tie with backup modes. Users can decide if this inverter can feed-in to the grid.

Allow battery to discharge when PV is available: This option is automatically determined by setting in "Load supply source (PV is available)". When "Battery" is higher priority than "Grid" in Load supply source (PV is available), this option is default selected. Under Grid-tie, this option is invalid.

Allow battery to discharge when PV is unavailable: This option is automatically determined by setting in "Load supply source (PV is unavailable)". When "Battery" is higher priority than "Grid" in Load supply source (PV is unavailable), this option is default selected. Under Grid-tie mode, this option is invalid.

Allow battery to feed-in to the Grid when PV is available: This option is only valid in Grid-tie with backup II or Grid-tie with backup III modes.

Allow battery to feed-in to the Grid when PV is unavailable: This option is only valid in all options of Grid-tie with backup mode.

## Grid-tie with backup

### ● Grid-tie with backup (I) :

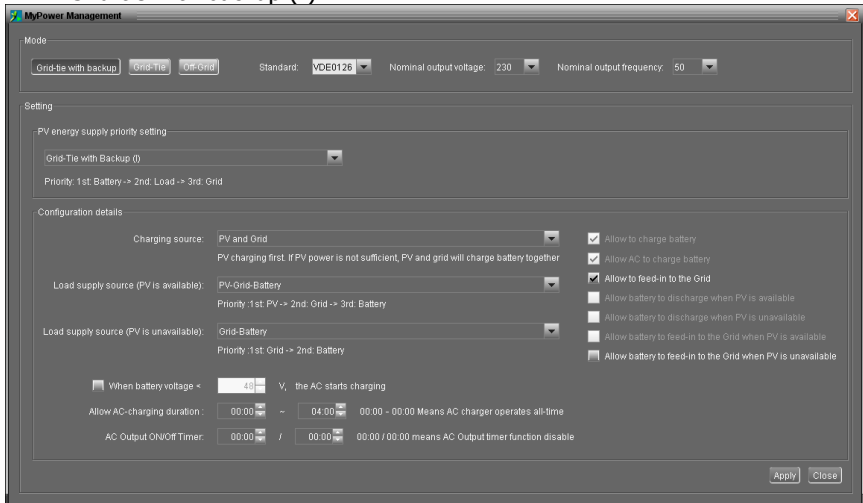

**PV energy supply priority setting: 1<sup>st</sup> Battery, 2<sup>nd</sup> Load and 3<sup>rd</sup> Grid.**

PV power will charge battery first, then provide power to the load. If there is any remaining power left, it will feed-in to the grid.

### Battery charging source:

1. PV and Grid (Default)

It's allowed to charge battery from PV power first. If it's not sufficient, grid will charge battery.

2. PV only

It is only allow PV power to charge battery.

3. None

It is not allowed to charge battery no matter it's from PV power or grid.

### Load supply source:

When PV power is available: 1<sup>st</sup> PV, 2<sup>nd</sup> Grid, 3<sup>rd</sup> Battery

If battery is not fully charged, PV power will charge battery first. And remaining PV power will provide power to the load. If it's not sufficient, grid will provide power to the load. If grid is not available at the same time, battery power will back up.

When PV power is not available:

1. 1<sup>st</sup> Grid, 2<sup>nd</sup> Battery (Default)

Grid will provide power to the load at first. If grid is not available, battery power will provide power backup.

2. 1<sup>st</sup> Battery, 2<sup>nd</sup> Grid

Battery power will provide power to the load at first. If battery power is running out, grid will back up the load.

**NOTE:** This option will become ineffective during AC charging time and the priority will automatically become 1<sup>st</sup> Grid and 2<sup>nd</sup> Battery order. Otherwise, it will cause battery damage.

### ● Grid-tie with backup (II) :

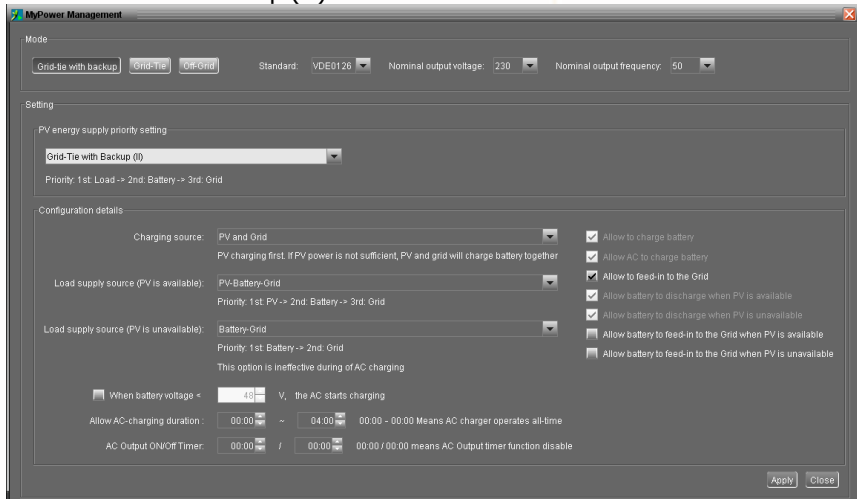

PV energy supply priority setting: 1<sup>st</sup> Load, 2<sup>nd</sup> Battery and 3<sup>rd</sup> Grid.

PV power will provide power to the load first. Then, it will charge battery. If there is any remaining power left, it will feed-in to the grid.

**Battery charging source:**

1. PV and Grid

It's allowed to charge battery from PV power first. If it's not sufficient, grid will charge battery.

2. PV only

It is only allow PV power to charge battery.

3. None

It is not allowed to charge battery no matter it's PV power or grid.

**Load supply source:**

When PV power is available:

1. 1<sup>st</sup> PV, 2<sup>nd</sup> Battery, 3<sup>rd</sup> Grid

PV power will provide power to the load first. If it's not sufficient, battery power will provide power to the load. When battery power is running out or not available, grid will back up the load.

2. 1<sup>st</sup> PV, 2<sup>nd</sup> Grid, 3<sup>rd</sup> Battery

PV power will provide power to the load first. If it's not sufficient, grid will provide power to the load. If grid is not available at the same time, battery power will back up.

When PV power is not available:

1. 1<sup>st</sup> Grid, 2<sup>nd</sup> Battery: Grid will provide power to the load at first. If grid is not available, battery power will provide power backup.

2. 1<sup>st</sup> Battery, 2<sup>nd</sup> Grid: Battery power will provide power to the load at first. If battery power is running out, grid will back up the load

**NOTE:** This option will become ineffective during AC charging time and the priority will automatically become 1<sup>st</sup> Grid and 2<sup>nd</sup> Battery order. Otherwise, it will cause battery damage.



## ● Grid-tie with backup (III):

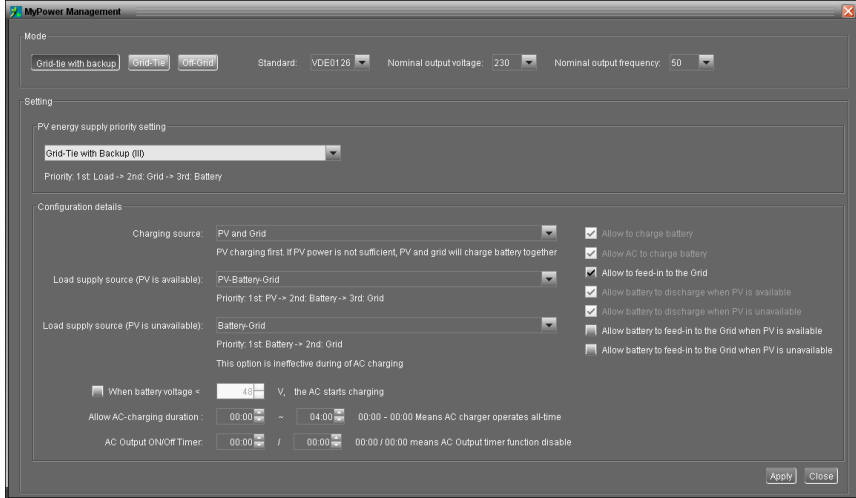

**PV energy supply priority setting:** 1<sup>st</sup> Load, 2<sup>nd</sup> Grid and 3<sup>rd</sup> Battery

PV power will provide power to the load first. If there is more PV power available, it will feed-in to the grid. If feed-in power reaches max. feed-in power setting, the remaining power will charge battery.

**NOTE:** The max. feed-in grid power setting is available in parameter setting. Please refer to software manual.

### **Battery charging source:**

1. PV and Grid: It's allowed to charge battery from PV power first. If it's not sufficient, grid will charge battery.
2. PV only: It is only allow PV power to charge battery.
3. None: It is not allowed to charge battery no matter it's PV power or grid.

### **Load supply source:**

When PV power is available:

1. 1<sup>st</sup> PV, 2<sup>nd</sup> Battery, 3<sup>rd</sup> Grid

PV power will provide power to the load first. If it's not sufficient, battery power will provide power to the load. When battery power is running out or not available, grid will back up the load.

2. 1<sup>st</sup> PV, 2<sup>nd</sup> Grid, 3<sup>rd</sup> Battery

PV power will provide power to the load first. If it's not sufficient, grid will provide power to the load. If grid is not available at the same time, battery power will back up.

When PV power is not available:

1. 1<sup>st</sup> Grid, 2<sup>nd</sup> Battery: Grid will provide power to the load at first. If grid is not available, battery power will provide power backup.

2. 1<sup>st</sup> Battery, 2<sup>nd</sup> Grid: Battery power will provide power to the load at first. If battery power is running out, grid will back up the load.

**NOTE:** This option will become ineffective during AC charging time and the priority will automatically become 1<sup>st</sup> Grid and 2<sup>nd</sup> Battery order. Otherwise, it will cause battery damage.

- Grid-tie with backup (IV): Users are only allowed to set up peak time and off-peak electricity demand.

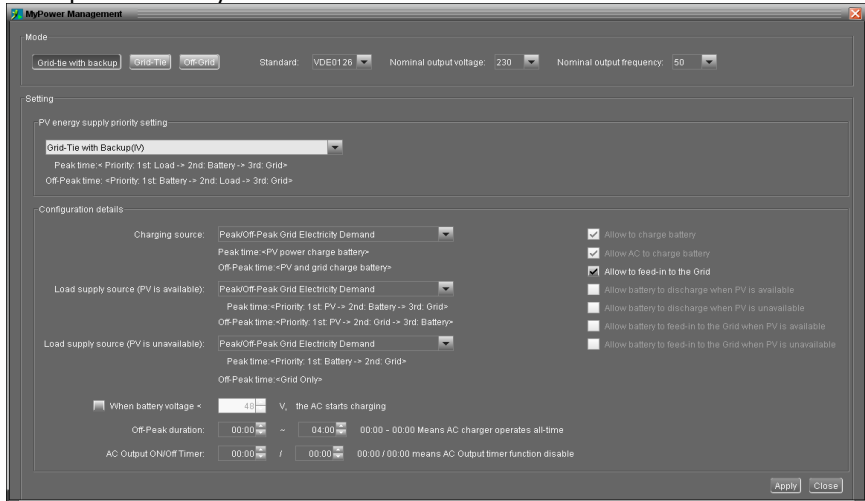

### Working logic under peak time:

**PV energy supply priority:** 1<sup>st</sup> Load, 2<sup>nd</sup> Battery and 3<sup>rd</sup> Grid

PV power will provide power to the load first. If PV power is sufficient, it will charge battery next. If there is remaining PV power left, it will feed-in to the grid. Feed-in to the grid is default disabled.

**Battery charging source:** PV only

Only after PV power fully supports the load, the remaining PV power is allowed to charge battery during peak time.

**Load supply source:** 1<sup>st</sup> PV, 2<sup>nd</sup> Battery, 3<sup>rd</sup> Grid

PV power will provide power to the load first. If PV power is not sufficient, battery power will back up the load. If battery power is not available, grid will provide the load. When PV power is not available, battery power will supply the load first. If battery power is running out, grid will back up the load.

### Working logic under off-peak time:

**PV energy supply priority:** 1<sup>st</sup> Battery, 2<sup>nd</sup> Load and 3<sup>rd</sup> Grid

PV power will charge battery first. If PV power is sufficient, it will provide power to the loads. The remaining PV power will feed to the grid.

**NOTE:** The max. feed-in grid power setting is available in parameter setting.

Please refer to software manual.

**Battery charging source:** PV and grid charge battery

PV power will charge battery first during off-peak time. If it's not sufficient, grid will charge battery.

**Load supply source:** 1<sup>st</sup> PV, 2<sup>nd</sup> Grid, 3<sup>rd</sup> Battery

When battery is fully charged, remaining PV power will provide power to the load first. If PV power is not sufficient, grid will back up the load. If grid power is not available, battery power will provide power to the load.

## Grid-Tie

Under this operation mode, PV power only feeds-in to the grid. No priority setting is available.

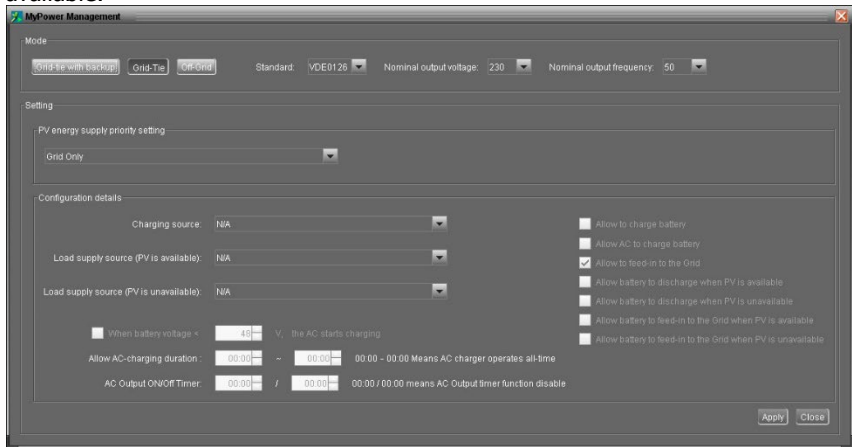

## Off-Grid

### ● Off-Grid (I): Default setting for off-grid mode.

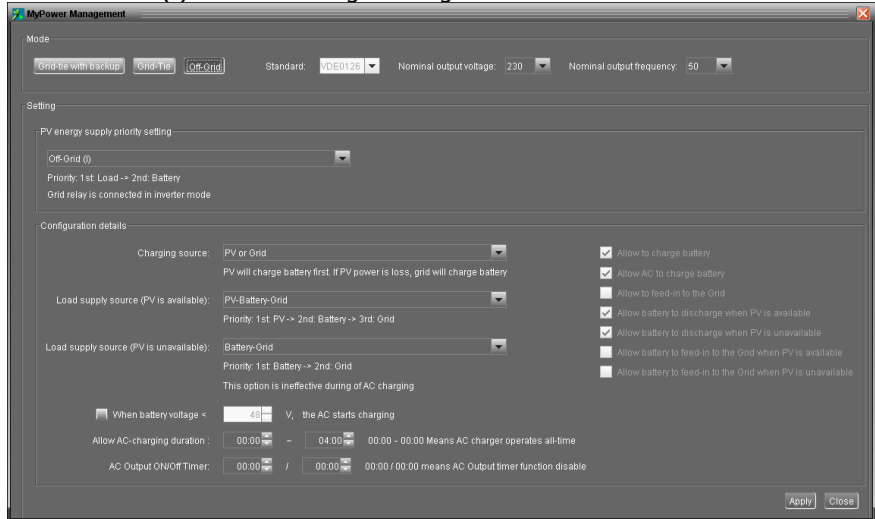

**PV energy supply priority setting:** 1<sup>st</sup> Load, 2<sup>nd</sup> Battery

PV power will provide power to the load first and then charge battery. Feed-in to the grid is not allowed under this mode. At the same time, the grid relay is connected in Inverter mode. That means the transfer time from inverter mode to battery mode will be less than 15ms. Besides, it will avoid overload fault because grid can supply load when connected load is over rated output capacity of the inverter.

**Battery charging source:**

1. PV or Grid: If there is remaining PV power after supporting the loads, it will charge battery first. Only until PV power is not available, grid will charge battery. (Default)
2. PV only: It is only allow PV power to charge battery.
3. None: It is not allowed to charge battery no matter it's PV power or grid.

**Load supply source:**

When PV power is available:

1. 1<sup>st</sup> PV, 2<sup>nd</sup> Battery, 3<sup>rd</sup> Grid (Default)

PV power will provide power to the load first. If it's not sufficient, battery power will provide power to the load. When battery power is running out or not available, grid will back up the load.

2. 1<sup>st</sup> PV, 2<sup>nd</sup> Grid, 3<sup>rd</sup> Battery

PV power will provide power to the load first. If it's not sufficient, grid will provide power to the load. If grid is not available at the same time, battery power will back up.

When PV power is not available:

## 1. 1<sup>st</sup> Grid, 2<sup>nd</sup> Battery

Grid will provide power to the load at first. If grid is not available, battery power will provide power backup.

## 2. 1<sup>st</sup> Battery, 2<sup>nd</sup> Grid (Default)

Battery power will provide power to the load at first. If battery power is running out, grid will back up the load.

**NOTE:** This option will become ineffective during AC charging time and the priority will automatically become 1<sup>st</sup> Grid and 2<sup>nd</sup> Battery order. Otherwise, it will cause battery damage.

## ● Off-Grid (II)

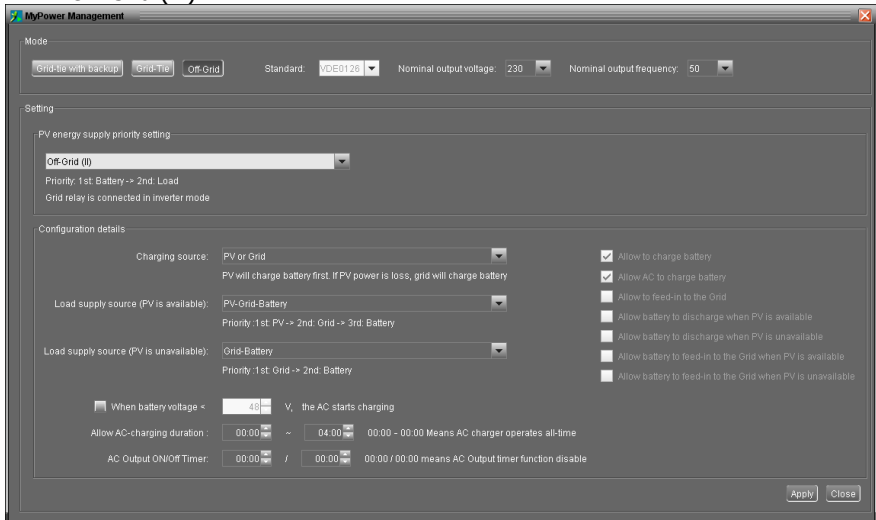

### PV energy supply priority setting: 1<sup>st</sup> Battery, 2<sup>nd</sup> Load

PV power will charge battery first. After battery is fully charged, if there is remaining PV power left, it will provide power to the load. Feed-in to the grid is not allowed under this mode. At the same time, the grid relay is connected in Inverter mode. That means the transfer time from inverter mode to battery mode will be less than 15ms. Besides, it will avoid overload fault because grid can supply load when connected load is over rated output capacity of the inverter.

### Battery charging source:

1. PV or Grid: If there is remaining PV power after supporting the loads, it will charge battery first. Only until PV power is not available, grid will charge battery.
2. PV only: It is only allow PV power to charge battery.
3. None: It is not allowed to charge battery no matter it's PV power or grid.

**NOTE:** It's allowed to set up AC charging duration.

### Load supply source:

When PV power is available: 1<sup>st</sup> PV, 2<sup>nd</sup> Grid, 3<sup>rd</sup> Battery

PV power will provide power to the load first. If it's not sufficient, grid will provide power to the load. If grid is not available at the same time, battery power will back up.

When PV power is not available:

1. 1<sup>st</sup> Grid, 2<sup>nd</sup> Battery: Grid will provide power to the load at first. If grid is not available, battery power will provide power backup.
2. 1<sup>st</sup> Battery, 2<sup>nd</sup> Grid: Battery power will provide power to the load at first. If battery power is running out, grid will back up the load.

**NOTE:** This option will become ineffective during AC charging time and the priority will automatically become 1<sup>st</sup> Grid and 2<sup>nd</sup> Battery order. Otherwise, it will cause battery damage.

### ● Off-Grid (III)

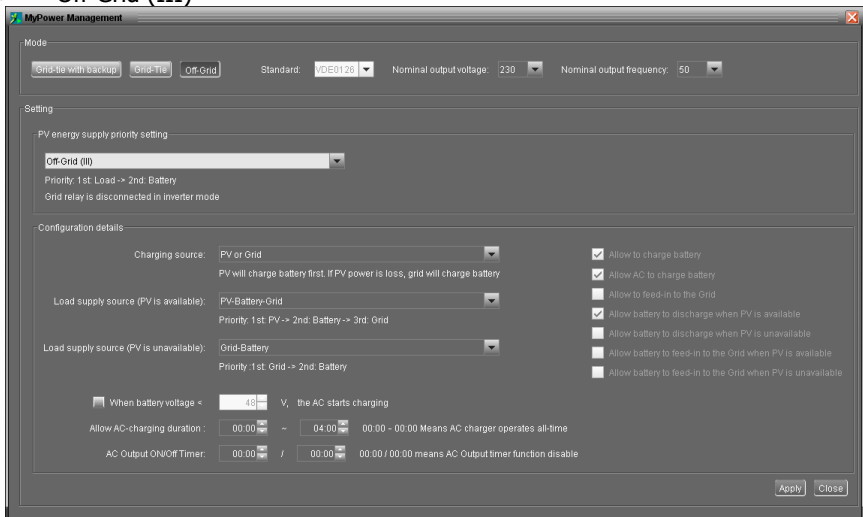

#### **PV energy supply priority setting: 1<sup>st</sup> Load, 2<sup>nd</sup> Battery**

PV power will provide power to load first and then charge battery. Feed-in to the grid is not allowed under this mode. The grid relay is NOT connected in Inverter mode. That means the transfer time from inverter mode to battery mode will be about 15ms. If connected load is over rated output capacity of the inverter and grid is available, this inverter will allow grid to provide power to the loads and PV power to charge battery. Otherwise, this inverter will activate fault protection.

#### **Battery charging source:**

1. PV or Grid: If there is remaining PV power after supporting the loads, it will charge battery first. Only until PV power is not available, grid will charge battery.
2. PV only: It is only allow PV power to charge battery.
3. None: It is not allowed to charge battery no matter it's PV power or grid.

**NOTE:** It's allowed to set up AC charging duration.

**Load supply source:**

When PV power is available: 1<sup>st</sup> PV, 2<sup>nd</sup> Battery, 3<sup>rd</sup> Grid

PV power will provide power to the load first. If it's not sufficient, battery power will back up the load. Only after battery power is running, Grid will back up the load.

When PV power is not available:

1. 1<sup>st</sup> Grid, 2<sup>nd</sup> Battery: Grid will provide power to the load at first. If grid is not available, battery power will provide power backup.
2. 1<sup>st</sup> Battery, 2<sup>nd</sup> Grid: Battery power will provide power to the load at first. If battery power is running out, grid will back up the load.

**NOTE:** This option will become ineffective during AC charging time and the priority will automatically become 1<sup>st</sup> Grid and 2<sup>nd</sup> Battery order. Otherwise, it will cause battery damage.

## 14. Operation

### 14-1. LCD Display Icons

The LCD is touchscreen, below screen shows the overall information of the inverter.

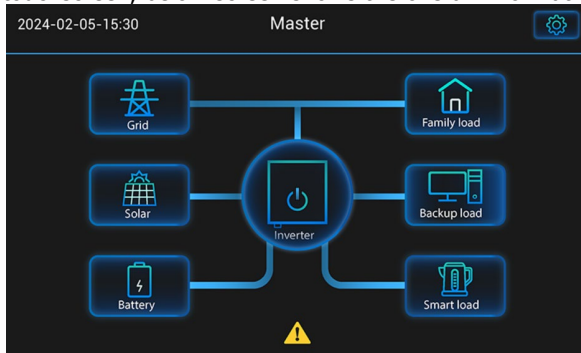

1. The top of the screen displays the time and Parallel status: Single/Host/ Slave.
  2. System settings icon, press this setting button to enter the system settings screen Including general setting, output setting, batter setting , system operation Mode setting, Grid setting, Calibration mode setting.
  3. The top of the screen displays the time and Parallel status: Single/Host/ Slave.
  4. System settings icon, press this setting button to enter the system settings screen Including general setting, output setting, batter setting , system operation Mode setting, Grid setting, Calibration mode setting.
  5. The main screen show information including inverter solar, grid/ Generator, battery ,load(family load, backup load, smart load) and warning/fault code. It also displays the direction of energy flow through arrows, clearly showing the working status of the inverter.
- **Main Screen – System On/ Off**
    1. Hold on "Inverter" icon in Main page 3s to enter this page. Control the inverter Turn on or turn off through this page
    2. Press ESC icon return to main screen.



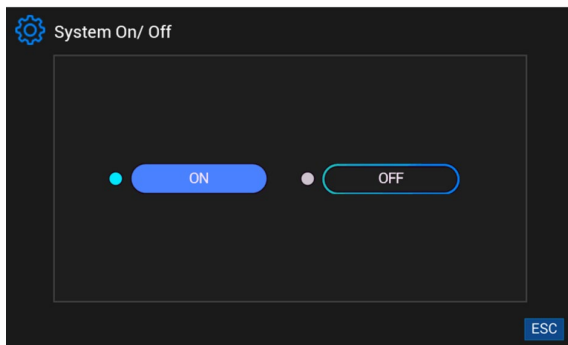

- **Main Screen - Grid**

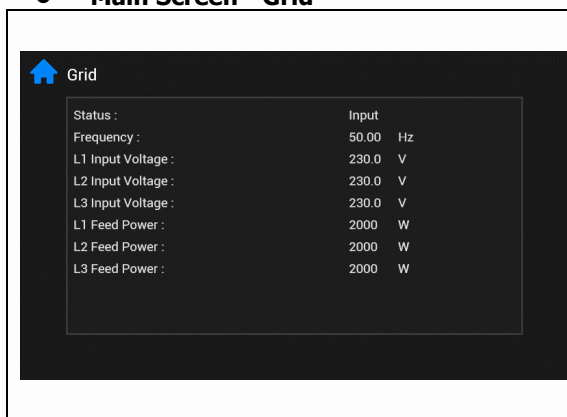

**This is Grid detail page**

This page tells grid status, grid voltage, grid frequency and feed power. Press HOME icon return to main screen.

Feed power negative means sell to grid, positive means get from grid

Status negative means sell to grid, positive means get from grid

- **Main Screen – Solar**

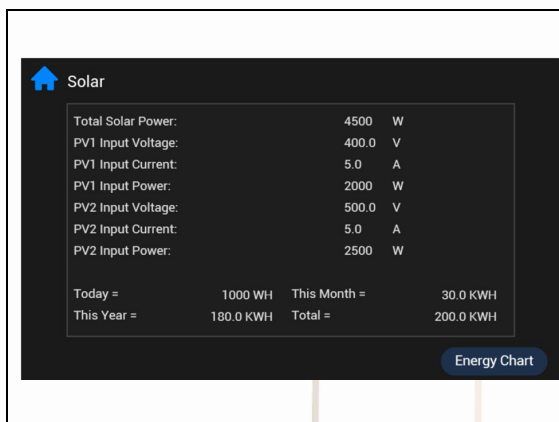

**This is Solar detail page**

This page tells total solar power, PV1&PV2 voltage, current, power. And this page also shows Solar Panel energy generated today/ this month/ this year/ Solar Panel energy generated totally

Press "Energy Chart" enter power curve page.

Press HOME icon return to main screen.



### Solar Power Flow: Month

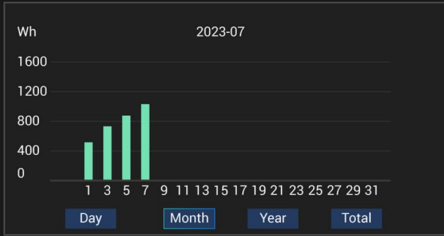

ESC



### Solar Power Flow: Day

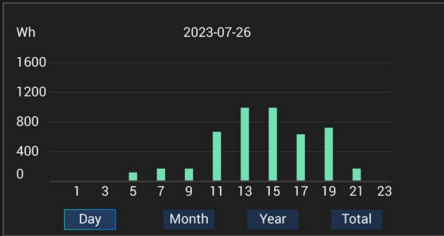

ESC



### Solar Power Flow: Year



ESC

### This is Solar Power Flow:

Solar power curve for daily, monthly, yearly and total can be checked on the LCD, We can also view more detailed power generation through the monitoring system.

Press HOME icon return to main screen.

Press "ESC" icon back to previous page.

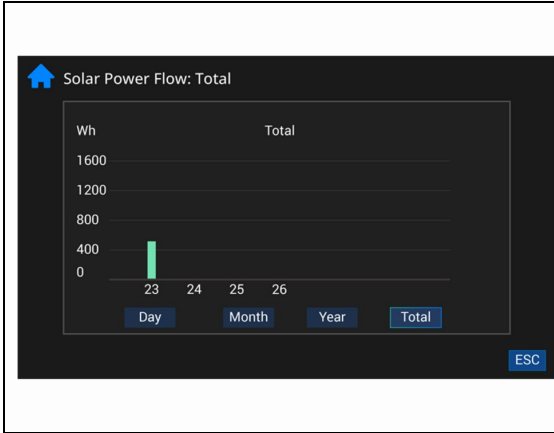

**This is Grid detail page**

This page tells grid status, grid voltage, grid frequency and feed power. Press HOME icon return to main screen.

Feed power negative means sell to grid, positive means get from grid

Status negative means sell to grid, positive means get from grid

● **Main Screen - Battery**

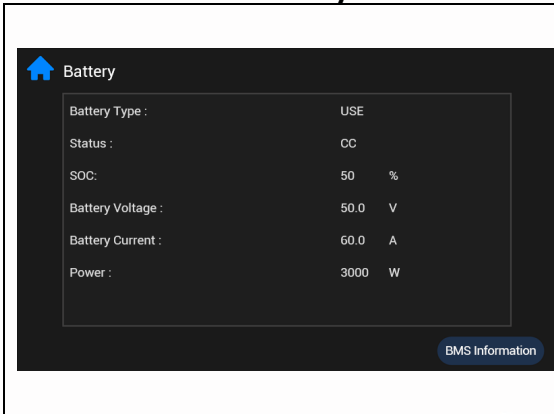

**This is Battery detail page**

1. This page tells the battery Type, statue, SOC, voltage, current and power.
2. If you if you use lithium battery, You can press "BMS Information" to check lithium battery information.

Press HOME icon return to main screen.

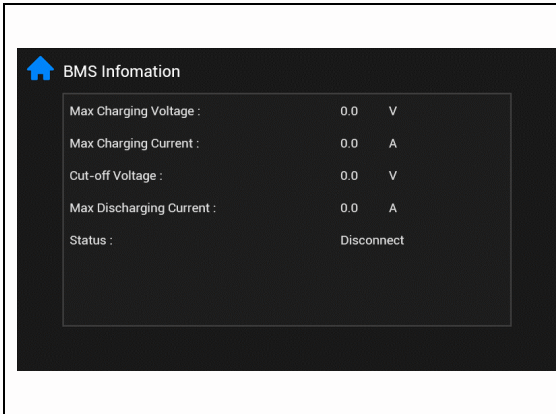

Press "ESC" icon back to previous page.

● **Main Screen - Inverter**

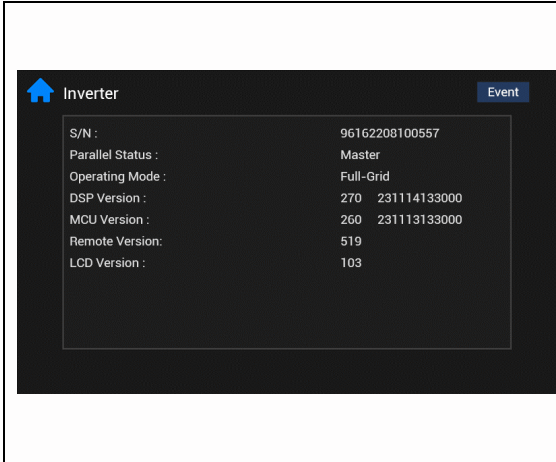

**This is Battery detail page**

This page tells the inverter detailed information , including the serial number, parallel status, operating mode, DSP version, MCU version, remote version, and LCD version of the inverter.

Press HOME icon return to main screen.

Press "Event" show Fault code page

● **Main Screen – Load**

The load information on the main screen includes three types: **Family load**, **backup load**, and **smart load**. We can read detailed load data through these pages.

### Family Load

L1 Output Voltage :	0.0	V
L2 Output Voltage :	0.0	V
L3 Output Voltage :	0.0	V

### This is family load page

This page tells the Family load information, including output voltage, Output current, each phase Power, and total power.

Press HOME icon return to main screen.

### Backup Load

L1 Output Voltage :	230.0	V
L2 Output Voltage :	230.0	V
L3 Output Voltage :	230.0	V
L1 Output Current :	13.0	A
L2 Output Current :	13.0	A
L3 Output Current :	5.0	A
L1 Output Active Power :	3000	W
L2 Output Active Power :	3000	W
L3 Output Active Power :	990	W
Total Output Active Power :	6990	W

### This is Backup load page

This page tells the backup load information, including output voltage, Output current, active power and apparent power. This page also tells the output frequency and output power percent.

Press HOME icon return to main screen.

### Backup Load

L1 Output Apparent Power :	3000	W
L2 Output Apparent Power :	3000	W
L3 Output Apparent Power :	990	W
Total Output Apparent Power :	6990	W
Output Frequency :	50.00	Hz
Output Power Percent :	60	%

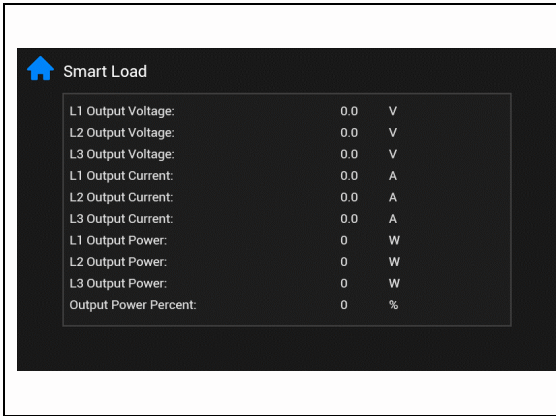

**This is smart load page**

This page tells the smart load information, including output voltage, Output current, each phase Power, and output power percent.

Press HOME icon return to main screen.

● **Main Screen – Fault /warning code**

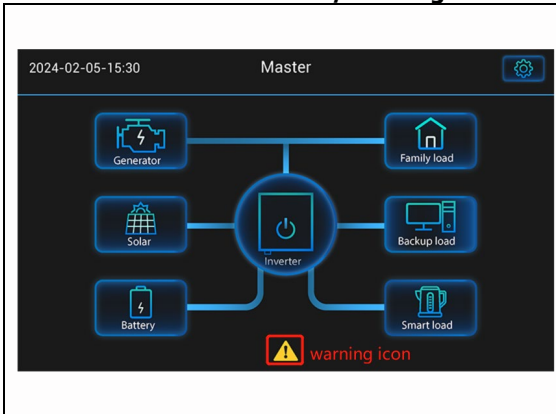

**This is Fault code detail page**

1. When the warning icon is currently displayed in screen, press the icon to check the detailed fault record of this Inverter. Fault code page will display the time when the Fault occurred, the Fault code, and description.

2. Press "Event" icon in Fault code page or Inverter page, to enter the warning information of this Inverter. This page will display the warning information.

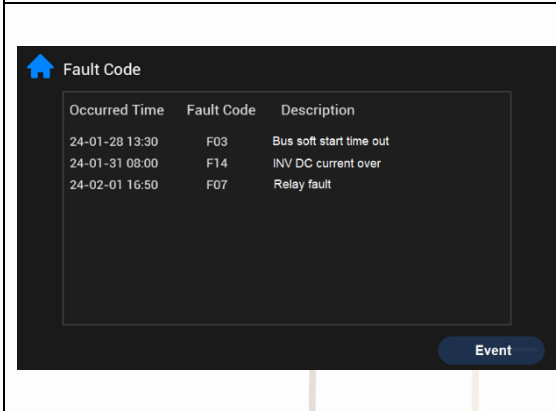

Press HOME icon return to main screen.

Press "Fault code" to check the fault recode.

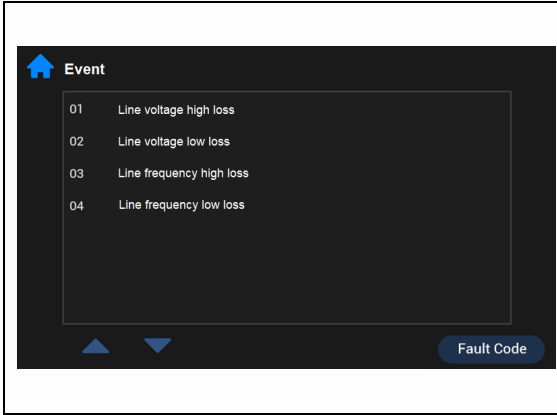

- **Main Screen - System Setting**

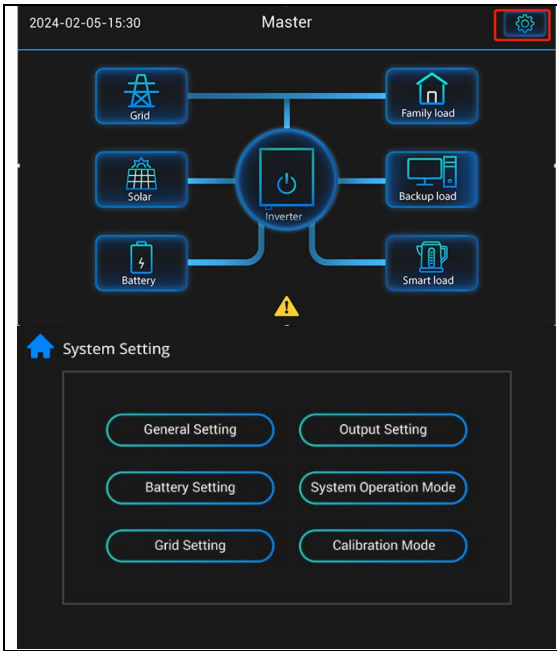

**This is System Setting detail page**

The system setting includes six types: General Setting, Output Setting, Battery Setting, System Operation Mode, Grid Setting and Calibration Mode.



## Main Screen - System Setting-General Setting

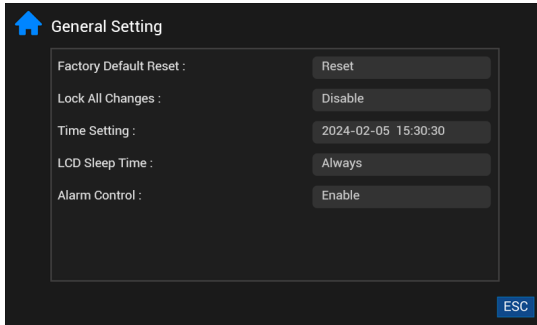

**This is General Setting detail page**

**Factory Reset:** Reset all parameters of the inverter.

**Lock out all changes:** Enable this menu for setting parameters that require locking and cannot be set up.

**Note:** Before successfully resetting and locking the system in the factory, you need to enter a password to set it up. The password for factory settings and lock all changes are 0000

**Time Setting:** Set system time.

**LCD Sleep Time:** LCD sleep time can be set always/30 seconds/ 1 minute /never.

**Alarm control:** Can set enable or disable alarms.

## Main Screen - System Setting-Output Setting

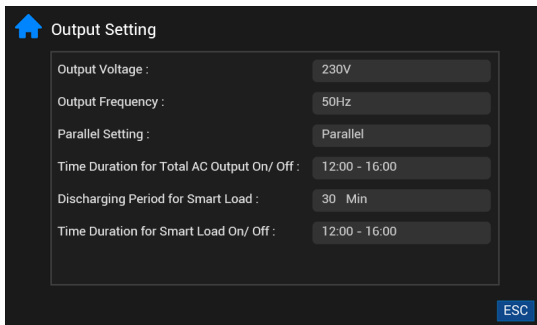

**This is Output Setting detail page**

**Output voltage:** The output Voltage can be set 220/ 230/ 240 V

**Output frequency:** The frequency can be set 50/ 60 Hz

**Parallel Setting:** You can modify this parameter to set it to single mode or parallel mode.

**Time Duration for Total AC output on/ off:** Modify this parameter to control output ON/OFF

**Discharging Period for Smart Load:** Modify this parameter to set the smart load Discharging Period.

**Time Duration for Smart Load On/ Off:** Modify this parameter to set Time Duration for the smart load



## Main Screen - System Setting-Battery setting

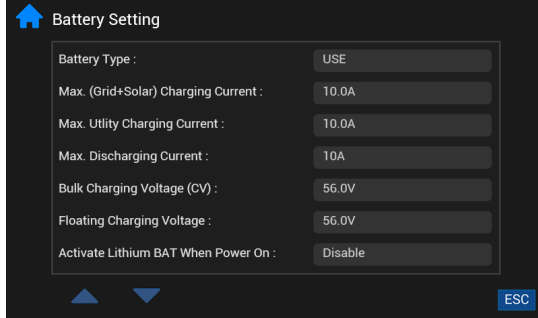

**This is Battery Setting detail page**

**Battery type:** "Use" means lead-acid battery, while others are lithium battery protocols.

### **Max(Grid+ Solar) Charging Current:**

For the 15KW model, the maximum charging current that can be set is 300A

For the 12KW model, the maximum charging current that can be set is 250A

### **Max. Utility Charging Current**

For the 15KW model, the maximum charging current that can be set is 300A

For the 12KW model, the maximum charging current that can be set is 250A

### **Max. Discharging Current**

For the 15KW model, the maximum discharging current that can be set is 370A

For the 12KW model, the maximum discharging current that can be set is 300A

**CV Voltage:** Setting range is from 48.0V to 60.0V. If the battery type is lithium battery, this parameter follows its BMS voltage parameter

**Floating Voltage:** Setting range is from 48.0V to 60.0V If the battery type is lithium battery, this parameter follows its BMS voltage parameter

**Activate Lithium BAT When Power On:** Disable/Enable

**Battery low cut off and Re-**

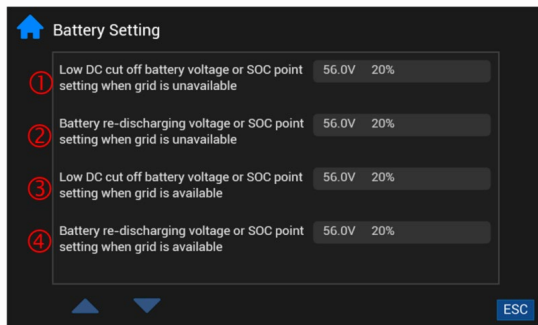

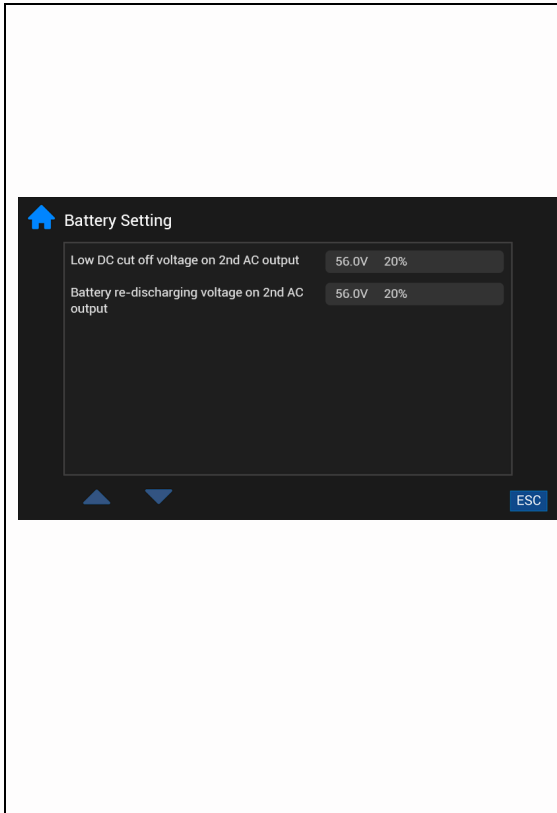

**discharging setting :** ① ② ③ ④

You can customize battery low cut off voltage/SOC and Re-discharging voltage/SOC.

**SOC control Smart load output:**

This mode can set the threshold of SOC to control the output of Smart load. When the battery SOC/voltage exceeds the user's programmable threshold, Smart load will ON.

**e.g. cut off SOC:90% , Re-discharging SOC: 95%**

When the battery pack SOC reaches 95%, the smart load port will switch on automatically and supply power to the connected load.

When the battery pack SOC < 90%, the smart load will switch OFF automatically.

We can also set the Discharging Period and Time Duration for smart load on the output settings page

**Main screen- System Setting- System Operation Mode**

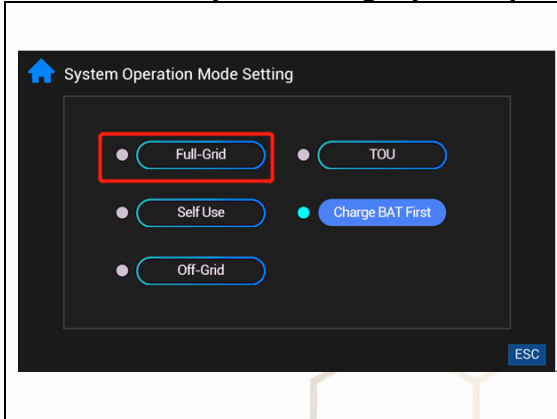

**Full-Grid mode:**

This mode allows hybrid inverters to feed excess power from solar panels into the grid. If "BAT Energy Feed to Grid Function" is enabled, battery energy can also be feed to the grid. Power source priority for the load is as follows:

1. Solar panels
2. Battery (until SOC or voltage reaches the Re-discharging point).
3. Grid

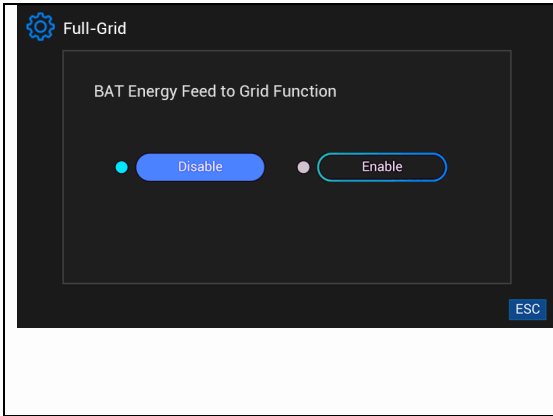

### TOU mode (Time Of Use)

The battery charging time/discharging time by utility can be set by user.

#### Note:

1. When the time is at charging time, the Grid will charge the battery.
2. When time is not in charging time but in discharging time, PV and battery will have priority support for load, and then feedback to grid if there is excess energy
3. When the time is neither charging time nor discharging time, the battery will not discharge the load even though the battery SOC is full.

#### For example

Charging Time Duration1: 19:00-23:30

Discharging Time Duration: 08:00-14:00

#### During 23: 30-08: 00:

The grid will not charge the battery. And the battery will not discharge the load.

#### During 08: 00-14: 00:

PV and battery will have priority support for load, and then feedback

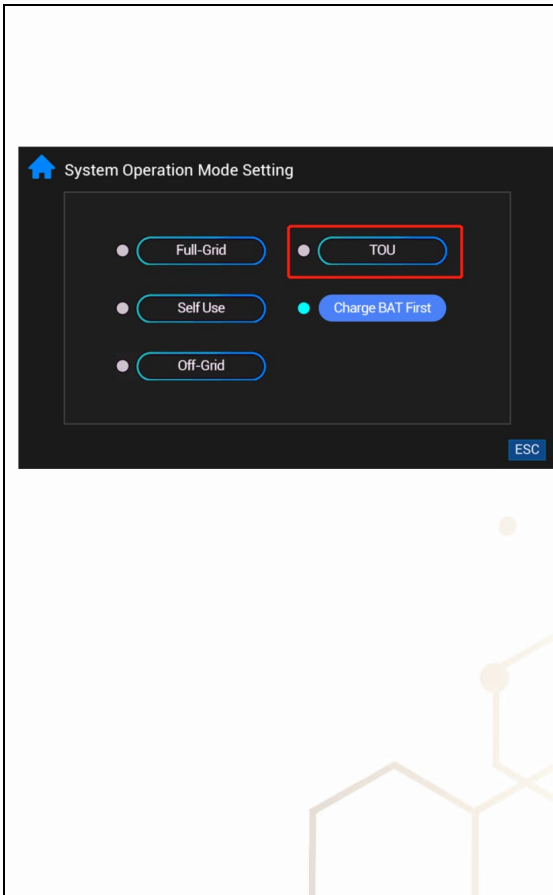

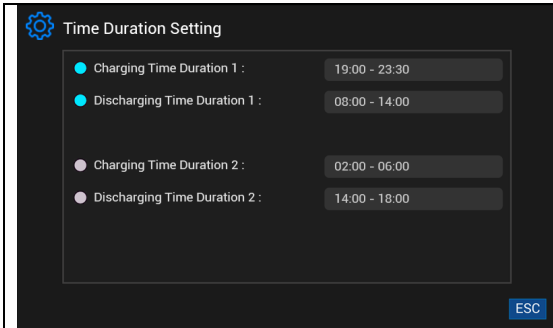

to grid if there is excess energy  
**During 14: 00-19: 00:**  
 The grid will not charge the battery.  
 And the battery will not discharge the load.  
**During 19: 00-23: 30:**  
 The grid will charge the battery.

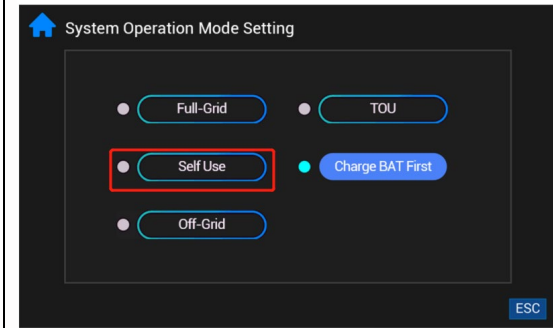

**Self use mode:**  
 Hybrid inverter will give power to the family load. If the PV power and battery power are less than the family load, the grid energy will be used as a supplement. However, the inverter cannot feed energy into the grid. In this mode, we will use electricity meters and modbus card to achieve this function. The electricity meters will detect power flowing back to the grid and will reduce the power of the inverter only to supply the backup load, charge battery and family load.

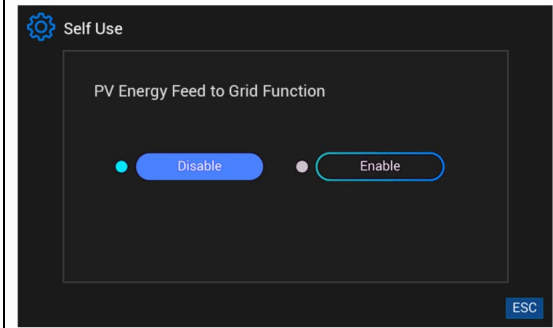

**PV energy feed to grid:**  
 If enabled, the PV will feed the excess energy back into the grid.  
 If not enabled, the PV will not feed into the grid.  
**Please refer to** "Application with Energy Meter"  
 for the installation method of electricity meters and modbus cards

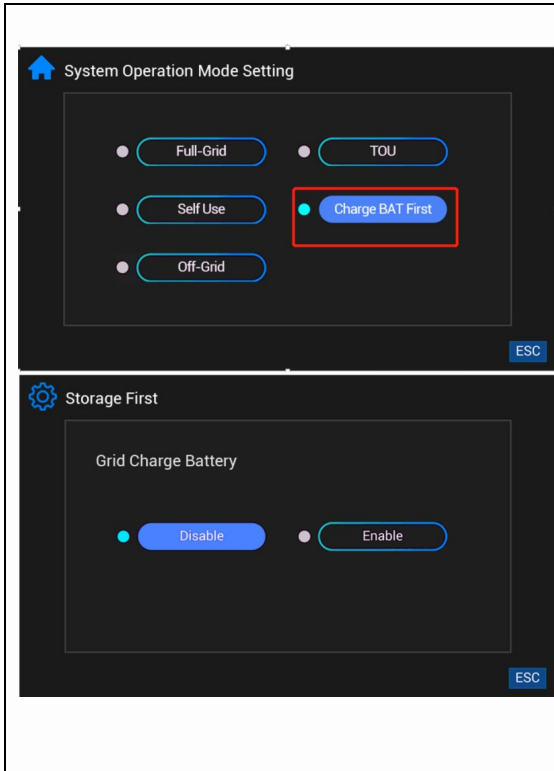

### Charge First:

#### The grid charge battery is enable:

PV power is firstly used to charge the battery and then used to power the load. If PV power is insufficient, grid will charge for battery and provide the energy load.

#### The grid charge battery is disable:

PV power is firstly used to charge the battery and then used to power the load. If PV power is insufficient, grid will provide the energy load. But, grid will not charge battery. PV power will charge battery.

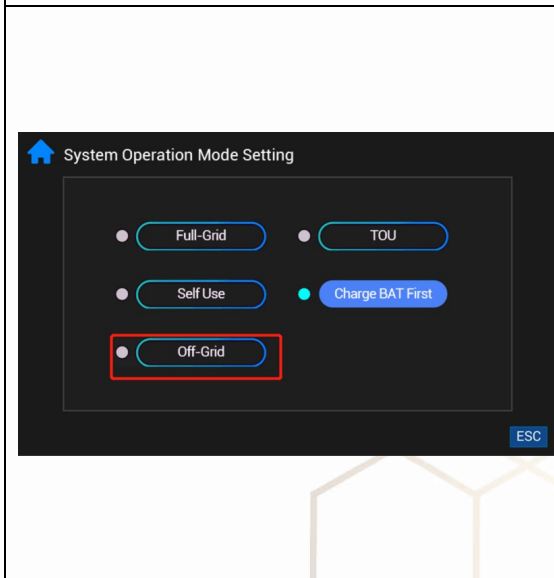

### Off-Grid:

#### Generator/Grid charge battery Disable:

PV and battery provide energy to the load. When the energy of PV and battery is insufficient and less than the load, the grid will provide energy to the load. The PV provide energy to charge battery.

#### Generator/Grid charge battery Enable:

PV and battery provide energy to the load. When the energy of PV and battery is insufficient and less than the load, the grid will provide energy to the load. And the Grid and PV charge the battery together.

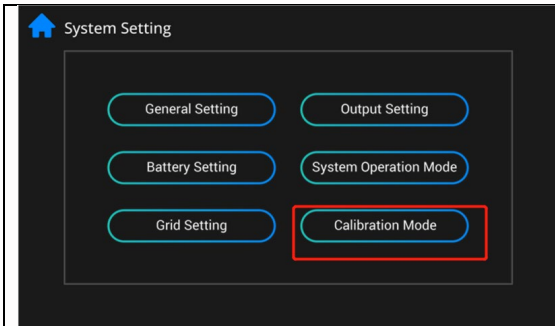
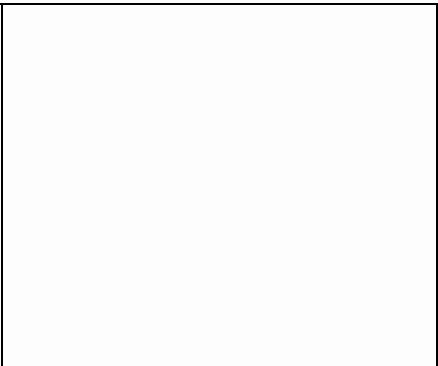
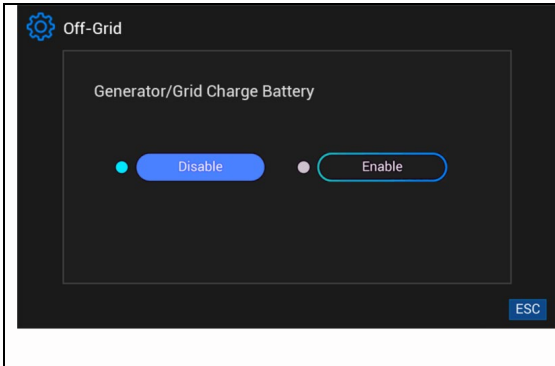

**Calibration Mode:**  
 After replacing the control board of the inverter, the voltage and current sampling of the inverter need to be recalibrated. This mode requires a password. If you have any requirements, please contact the installer to provide a password.

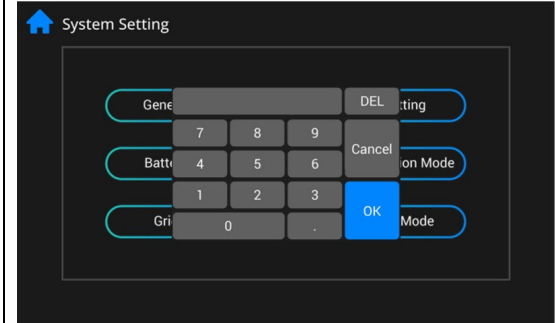



## Calibration Mode

Bus Voltage Calibration

Output Voltage Calibration

Output Current Calibration

Inverter Voltage Calibration

Battery Voltage Calibration

ESC

## 15. Charging Management

Charging Parameter	Default Value	Note
Charging current	60A	For 12KW model, it can be adjusted via software from 10Amp to 250Amp. For 15KW model, it can be adjusted via software from 10Amp to 300Amp.
Floating charging voltage (default)	54.0 Vdc	It can be adjusted via software from 50Vac to 60Vdc.
Max. absorption charging voltage (default)	56.0 Vdc	It can be adjusted via software from 50Vac to 60Vdc.
Battery overcharge protection	62.0 Vdc	
<p>Charging process based on default setting.</p> <p>3 stages:</p> <p>First – max. charging voltage increases to 56V;</p> <p>Second- charging voltage will maintain at 56V until charging current is down to 12 Amp;</p> <p>Third- go to floating charging at 54V.</p>		

This inverter can connect to battery types of sealed lead acid battery, vented battery, gel battery and lithium battery. The detail installation and maintenance explanations of the external battery pack are provided in the manufacturer's external battery pack of manual.



If using sealed lead acid battery, please set up the max. charging current according to below formula:

$$\text{The maximum charging current} = \text{Battery capacity (Ah)} \times 0.2$$

For example, if you are using 300 Ah battery, then, maximum charging current is  $300 \times 0.2 = 60$  (A). Please use at least 50Ah battery because the settable minimum value of charging current is 10A. If using AGM/Gel or other types of battery, please consult with installer for the details.

Below is setting screen from software:

**Parameters setting**

Min. grid-connected voltage: 184 V	Apply	The waiting time before grid-connection: 60 Sec.	Apply
Max. grid-connected voltage: 264.5 V	Apply	Max. grid-connected average voltage: 253 V	Apply
Min. grid-connected frequency: 47.48 Hz	Apply	Max. feed-in grid power: 10,000 W	Apply
Max. grid-connected frequency: 51.5 Hz	Apply		
Min. PV input voltage: 300 V	Apply	Floating charging voltage: 54 V	Apply
Max. PV input voltage: 900 V	Apply	Battery cut-off discharging voltage when Grid is available: 48 V	Apply
Min. MPP voltage: 350 V	Apply	Battery re-discharging voltage when Grid is available: 54 V	Apply
Max. MPP voltage: 850 V	Apply	Battery cut-off discharging voltage when Grid is unavailable: 42 V	Apply
Max. charging current: 60 A	Apply	Battery re-discharging voltage when Grid is unavailable: 48 V	Apply
Max. AC charging current: 60 A	Apply	Battery temperature compensation: 0 mV	Apply
Bulk charging voltage (C.V. voltage): 56 V	Apply	Feeding grid power calibration: 0 W	Apply
Start LCD screen-saver after: None Sec.	Apply	Max. battery discharge current in hybrid mode: 10 A	Apply
Mute Buzzer alarm: <input type="radio"/> Enable <input checked="" type="radio"/> Disable	Apply	Generator as AC source: <input type="radio"/> Enable <input checked="" type="radio"/> Disable	Apply
Mute the buzzer in the Standby mode: <input type="radio"/> Enable <input checked="" type="radio"/> Disable	Apply	Activate Li-Fe battery while commissioning: <input type="radio"/> Yes <input checked="" type="radio"/> No	Apply
Mute alarm in battery mode: <input type="radio"/> Enable <input checked="" type="radio"/> Disable	Apply	Wide AC input range: <input type="radio"/> Enable <input checked="" type="radio"/> Disable	Apply
When float charging current is less than X (A) and continued T (Min), then charger off, when battery voltage is less than Y (V), then charger on again.			
X: 0 A	T: 60 Min.	Y: 53 V	Apply
Any schedule change will affect the power generated and shall be conservatively made.			
System time: 2014-10-27			
14:03:21	Apply		
Close			

## 16. Maintenance & Cleaning

Check the following points to ensure proper operation of whole solar system at regular intervals.

- Ensure all connectors of this inverter are cleaned all the time.
- Before cleaning the solar panels, be sure to turn off PV DC breakers.
- Clean the solar panels, during the cool time of the day, whenever it is visibly dirty.
- Periodically inspect the system to make sure that all wires and supports are securely fastened in place.

**WARNING:** There are no user-replaceable parts inside of the inverter. Do not attempt to service the unit yourself.

### Battery Maintenance

- Servicing of batteries should be performed or supervised by personnel knowledgeable about batteries and the required precautions.
- When replacing batteries, replace with the same type and number of batteries or battery packs.
- The following precautions should be observed when working on batteries:
  - a) Remove watches, rings, or other metal objects.
  - b) Use tools with insulated handles.
  - c) Wear rubber gloves and boots.
  - d) Do not lay tools or metal parts on top of batteries.
  - e) Disconnect charging source prior to connecting or disconnecting battery terminals.
  - f) Determine if battery is inadvertently grounded. If inadvertently grounded, remove source from ground. Contact with any part of a grounded battery can result in electrical shock. The likelihood of such shock can be reduced if such grounds are removed during installation and maintenance (applicable to equipment and remote battery supplies not having a grounded supply circuit).

**CAUTION:** A battery can present a risk of electrical shock and high short-circuit current.

**CAUTION:** Do not dispose of batteries in a fire. The batteries may explode.

**CAUTION:** Do not open or mutilate batteries. Released electrolyte is harmful to the skin and eyes. It may be toxic.

## 17. Trouble Shooting

When there is no information displayed in the HMI, please check if PV module/battery/grid connection is correctly connected.

**NOTE:** The warning and fault information can be recorded by remote monitoring software.

### 17-1. Warning List

There are 20 situations defined as warnings. We can check warning code on “Main screen- Inverter Menu-Event” page. If there are several codes, it will display in sequences. Please contact your installer when you couldn't handle with the warning situations.

Code	Warning Event	Description
01	Line voltage high loss	Grid voltage is too high.
02	Line voltage low loss	Grid voltage is too low.
03	Line frequency high loss	Grid frequency is too high.
04	Line frequency low loss	Grid frequency is too low.
05	Line voltage loss for long time	Grid voltage is higher than 253V.
06	Ground Loss	Ground wire is not detected.
07	Island detect	Island operation is detected.
08	Line waveform loss	The waveform of grid is not suitable for inverter.
09	Line phase loss	The phase of grid is not in right sequence.
10	EPO detected	EPO is open.
11	Overload	Load exceeds rating value.
12	Over temperature	The temperature is too high inside.
13	Batter voltage low	Battery discharges to low alarm point.
14	Battery under-voltage when grid is loss	Battery discharges to shutdown point.
15	Battery open	Battery is unconnected or too low.
16	Battery under-voltage when grid is OK	Battery stops discharging when the grid is OK.
17	Solar over voltage	PV voltage is too high.
b0	Stop discharging battery	Informs inverter to stop discharging battery.
b1	Stop charging battery	Informs inverter to stop charging battery
B2	Charge battery	Informs inverter to charge battery.

## 17-2. Fault Reference Codes

When a fault occurs, error icon will be displayed, and the buzzer will sound continuously. See below for fault codes for reference.

Situation			Solution
Fault Code	Fault Event	Possible cause	
01	Bus voltage over	Surge	1. Restart the inverter. 2. If the error message still remains, please contact your installer.
02	BUS voltage under	PV or battery disconnect suddenly	1. Restart the inverter 2. If the error message still remains, please contact your installer.
03	BUS soft start time out	Internal components failed.	Please contact your installer.
04	INV soft start time out	Internal components failed.	Please contact your installer.
05	INV over current	Surge	1. Restart the inverter. 2. If the error message still remains, please contact your installer.
06	Over temperature	Internal temperature is too high.	1. Check the ambient temperature and fans. 2. If the error message still remains, please contact your installer.
07	Relay fault	Internal components failed.	Please contact your installer.
08	CT sensor fault	Internal components failed.	Please contact your installer.
09	Solar input power abnormal	1. Solar input driver damaged. 2. Solar input power is too much when voltage is more than 850V.	1. Please check if solar input voltage is higher than 850V. 2. Please contact your installer.
11	Solar over current	Surge	1. Restart the inverter. 2. If the error message still remains, please contact your installer.

12	GFCI fault	Leakage current exceeds the limit.	1. Check the wire and panels which may cause the leakage.
13	PV ISO fault	The resistance between PV and ground is too low.	2. If the error message still remains, please contact your installer.
14	INV DC current over	Utility fluctuates.	1. Restart the inverter. 2. If the error message still remains, please contact your installer.
16	GFCI sensor fault	GFCI sensor failed.	Please contact your installer.
22	Battery high voltage fault	Battery voltage exceeds the limit.	1. Check the battery voltage. 2. If the error message still remains, please contact your installer.
23	Overload	The inverter is loaded with more than 110% load and time is up.	Reduced the connected load by switching off some equipment.
26	INV short	Output short circuited.	Check if wiring is connected well and remove abnormal load.
27	Fan lock	Fan failed.	Please contact your installer.
32	DC/DC over current	Internal components failed.	1. Restart the inverter. 2. If the error message still remains, please contact your installer.
33	INV voltage low	Internal components failed.	Please contact your installer.
34	INV voltage high	Internal components failed.	Please contact your installer.
36	OP voltage fault	Grid connects to output terminal.	Don't connect the grid to the output terminal.
38	Short circuit on PV input	Short circuited on PV input	Please contact your installer.
46	RS inverter short circuit	Short circuited on RS inverter	Check if all wiring is connected well and remove abnormal loads.
47	ST inverter short circuit	Short circuited on ST inverter	Check if all wiring is connected well and remove abnormal loads.
48	TR inverter short circuit	Short circuited on TR inverter	Check if all wiring is connected well and remove abnormal loads.

49	BUCK BOOST is over temperature	BUCK BOOST temperature is too high.	<ol style="list-style-type: none"> <li>1. Check the ambient temperature and fans.</li> <li>2. If the error message still remains, please contact your installer.</li> </ol>
50	Relay version error	Internal components failed.	Please contact your installer.
52	PV1 Over temperature	PV1 temperature is too high.	<ol style="list-style-type: none"> <li>1. Check the ambient temperature and fans.</li> <li>2. If the error message still remains, please contact your installer.</li> </ol>
53	PV2 Over temperature	PV2 temperature is too high.	<ol style="list-style-type: none"> <li>1. Check the ambient temperature and fans.</li> <li>2. If the error message still remains, please contact your installer.</li> </ol>
54	Inverter over temperature	Inverter temperature is too high.	<ol style="list-style-type: none"> <li>1. Check the ambient temperature and fans.</li> <li>2. If the error message still remains, please contact your installer.</li> </ol>
56	DCDC is over temperature	DCDC temperature is too high.	<ol style="list-style-type: none"> <li>1. Check the ambient temperature and fans.</li> <li>2. If the error message still remains, please contact your installer.</li> </ol>
57	Control board is over temperature	Control panel temperature is too high.	<ol style="list-style-type: none"> <li>1. Check the ambient temperature and fans.</li> <li>2. If the error message still remains, please contact your installer.</li> </ol>
58	External battery is over temperature	The temperature of external battery is too high.	<ol style="list-style-type: none"> <li>1. Check the ambient temperature and fans.</li> <li>2. If the error message still remains, please contact your installer.</li> </ol>
59	DC/DC board of battery is over temperature.	The temperature of DC/DC board in battery is too high.	<ol style="list-style-type: none"> <li>1. Check the ambient temperature and fans.</li> <li>2. If the error message still remains, please contact your installer.</li> </ol>

## 18. Specifications

<b>MODEL</b>	<b>12KW</b>	<b>15KW</b>
<b>RATED POWER</b>	12000 W	15000 W
<b>PV INPUT (DC)</b>		
Maximum DC Power	16000 W	22500 W
Nominal DC Voltage	720 VDC	
Maximum DC Voltage	1000 VDC	
Working DC Voltage Range	300 VDC ~ 1000 VDC	
Start-up Voltage / Initial Feeding Voltage	320 VDC / 350 VDC	
MPP Voltage Range / Full Load MPP Voltage Range	350 VDC ~ 950 VDC / 348 VDC ~ 900 VDC	350 VDC ~ 950 VDC / 348 VDC ~ 900 VDC
Maximum Input Current	26A + 26A	
Isc PV (absolute maximum)	30 A	
Max. inverter back feed current to the array	0 A	
<b>GRID OUTPUT (AC)</b>		
Nominal Output Voltage	230 VAC (P-N) / 400 VAC (P-P)	
Output Voltage Range	184 - 265 VAC per phase	
Output Frequency Range	47.5 ~ 51.5 Hz or 59.3~ 60.5Hz	
Nominal Output Current	17.4A per phase	21.7A per phase
Inrush Current/Duration	22 A per phase / 20ms	
Maximum Output Fault Current/Duration	66 A per phase / 1ms	
Maximum output Overcurrent Protection	66 A per phase	
Power Factor Range	0.9 lead – 0.9 lag	
<b>AC INPUT</b>		
AC Start-up Voltage	120-140 VAC per phase	
Auto Restart Voltage	180 VAC per phase	
Acceptable Input Voltage Range	170 - 290 VAC per phase	
Nominal Frequency	50 Hz / 60 Hz	
AC Input Power	12KVA/12KW	15KVA/15KW
Maximum AC Input Current	40 A	
Inrush Input Current	40 A / 1ms	
<b>BATTERY MODE OUTPUT (AC)</b>		
Nominal Output Voltage	230 VAC (P-N) / 400 VAC (P-P)	
Output Frequency	50 Hz / 60 Hz (auto sensing)	
Output Waveform	Pure sine wave	
Output Power	12KVA/12KW	15KVA/15KW
Efficiency (DC to AC)	91%	
<b>BATTERY &amp; CHARGER (Lead-acid/Li-ion)</b>		
DC Voltage Range	40 – 62 VDC	
Nominal DC Voltage	48 VDC	
Maximum Battery Discharging Current	300 A	375 A
Maximum Charging Current	250 A	300 A
<b>GENERAL</b>		
<b>PHYSICAL</b>		
Dimension, D X W X H (mm)	255 x 660 x 750	

Net Weight (kgs)	70	73
<b>INTERACE</b>		
Communication Port	RS-232/USB/RS485/CAN/WI-FI	
Intelligent Slot	Optional SNMP, Modbus cards available	
<b>ENVIRONMENT</b>		
Protective Class	I	
Ingress Protection Rating	IP65	
Humidity	0 ~ 100% RH (No condensing)	
Operating Temperature	-25 to 60°C (Power derating above 45°C)	
Altitude	Max. 1000m*	

\* Power derating 1% every 100m when altitude is over 1000m.



# Appendix I: Parallel Installation Guide

## Introduction

This inverter can be used in parallel with maximum 6 units.

## Parallel cable

You will find the following items in the package:

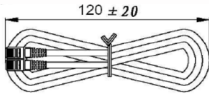

Parallel communication cable



Current sharing cable

## Overview

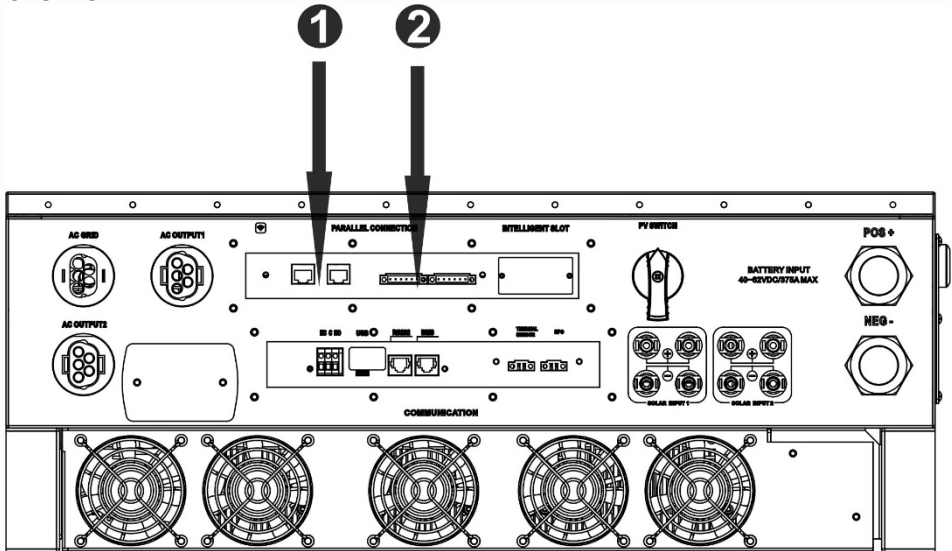

1. Parallel communication port
2. Current sharing port

## Mounting the Unit

When installing multiple units, please follow below chart.

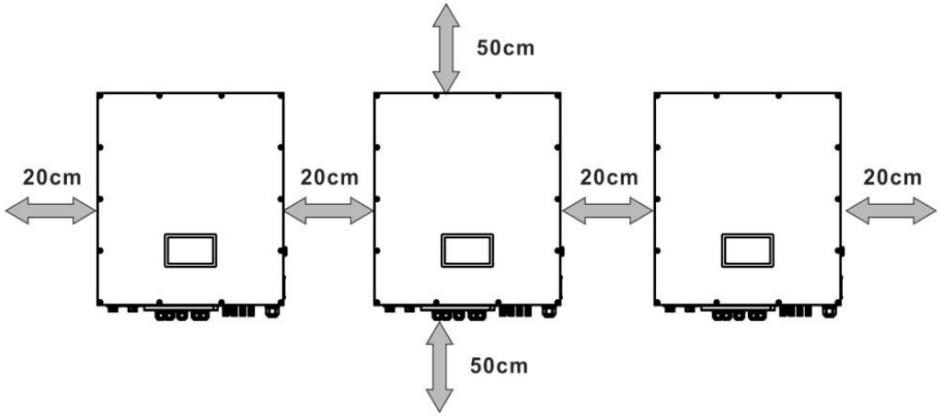

**NOTE:** For proper air circulation to dissipate heat, it's necessary to allow a clearance of approx. 50 cm to the side and approx. 20 cm above and below the unit. Be sure to install each unit in the same level.

## Wiring Connection

The cable size of each inverter is shown as below:

**Recommended battery cable and terminal size for each inverter:**

**Ring terminal:**

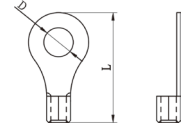

Model	Wire Size	Ring Terminal			Torque value
		Cable mm <sup>2</sup>	Dimensions		
			D (mm)	L (mm)	
12KW	4/0	107	8.4	54.2	7~12 Nm
15KW	300	151	8.4	54.2	7~12 Nm

**WARNING:** Be sure the length of all battery cables is the same. Otherwise, there will be voltage difference between inverter and battery to cause parallel inverters not working.

**Recommended AC input and output cable size for each inverter:**

Model	AWG no.	Conductor cross-section	Torque
12KW	10~8 AWG	5.5~10 mm <sup>2</sup>	1.4~1.6Nm
15KW	10~8 AWG	5.5~10 mm <sup>2</sup>	1.4~1.6Nm

You need to connect the cables of each inverter together. Take the battery cables for example. You need to use a connector or bus-bar as a joint to connect the battery

cables together, and then connect to the battery terminal. The cable size used from joint to battery should be X times cable size in the tables above. "X" indicates the number of inverters connected in parallel.

Regarding cable size of AC input and output, please also follow the same principle.

**CAUTION!!** Please install a breaker at the battery side. This will ensure the inverter can be securely disconnected during maintenance and fully protected from overcurrent of battery.

**Recommended breaker specification of battery for each inverter:**

Model	One unit*
12KW	350A/60VDC
15KW	450A/60VDC

\*If you want to use only one breaker at the battery side for the whole system, the rating of the breaker should be X times current of one unit. "X" indicates the number of inverters connected in parallel.

**Recommended battery capacity**

Inverter parallel numbers	2	3	4	5	6
Battery Capacity	800AH	1200AH	1600AH	2000AH	2400AH

**CAUTION!** Please follow the battery charging current and voltage from battery spec to choose the suitable battery. The wrong charging parameters will reduce the battery lifecycle sharply.

**Approximate back-up time table**

Load (W)	Backup Time @ 48Vdc 800Ah (min)	Backup Time @ 48Vdc 1200Ah (min)	Backup Time @ 48Vdc 1600Ah (min)	Backup Time @ 48Vdc 2000Ah (min)	Backup Time @ 48Vdc 2400Ah (min)
5,000	240	360	480	600	720
10,000	112	168	224	280	336
15,000	60	90	120	150	180
20,000	40	60	80	100	120
25,000	20	30	40	50	60
30,000	16	24	32	40	48

**PV Connection**

Please refer to user manual of single unit for PV Connection.

**CAUTION:** Each inverter should connect to PV modules separately.

## Inverters Configuration

Two inverters in parallel:

### Power Connection

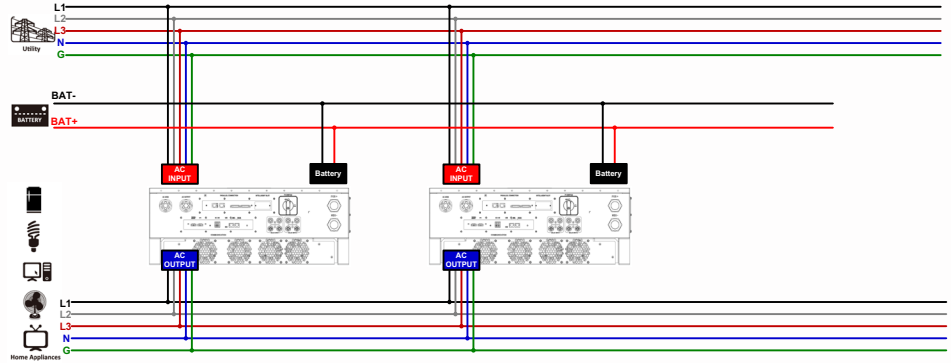

### Communication Connection

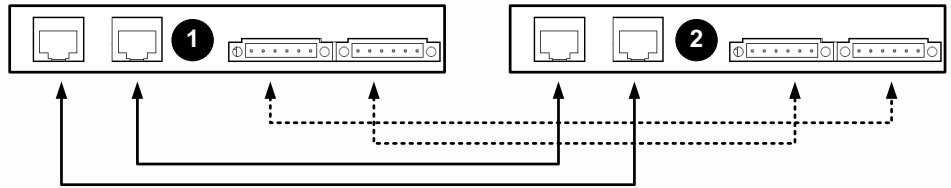

Three inverters in parallel:

### Power Connection

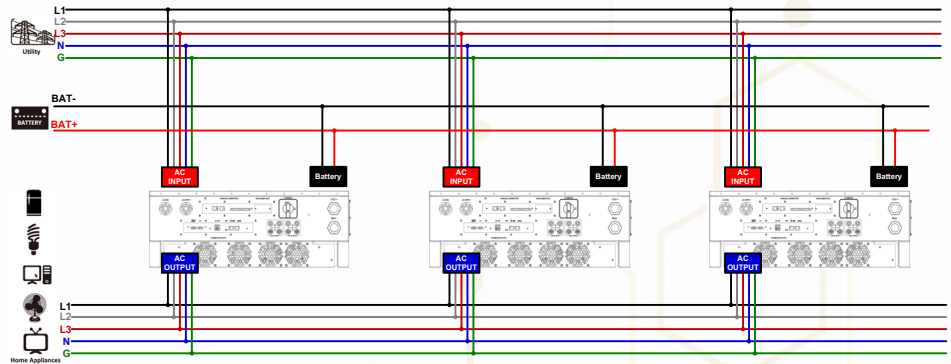

## Communication Connection

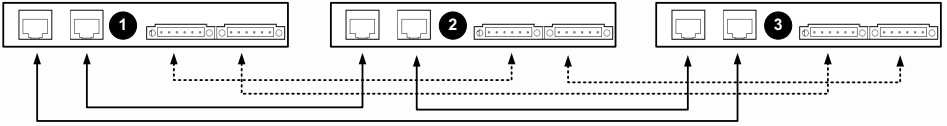

Four inverters in parallel:

## Power Connection

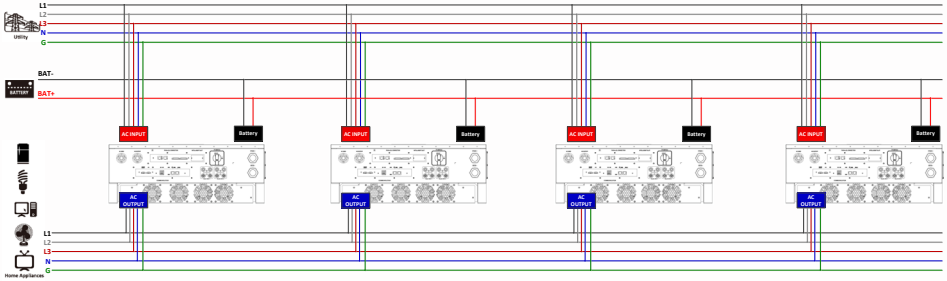

## Communication Connection

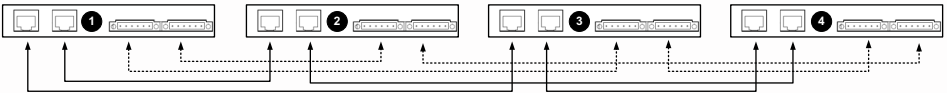

Five inverters in parallel:

## Power Connection

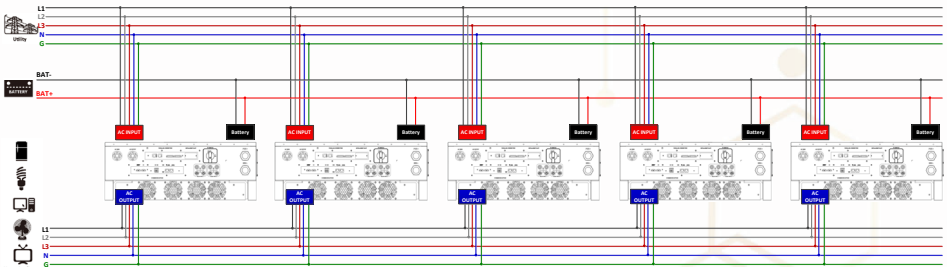

## Communication Connection

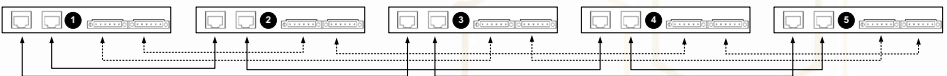

## Six inverters in parallel:

### Power Connection

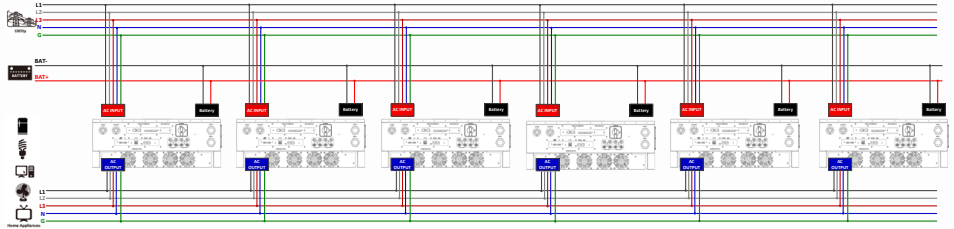

### Communication Connection

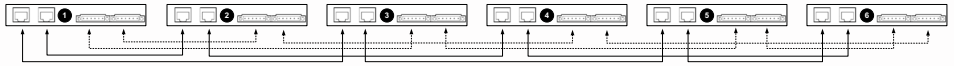

## Set parallel mode

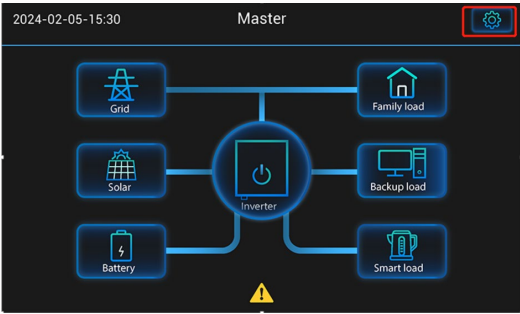
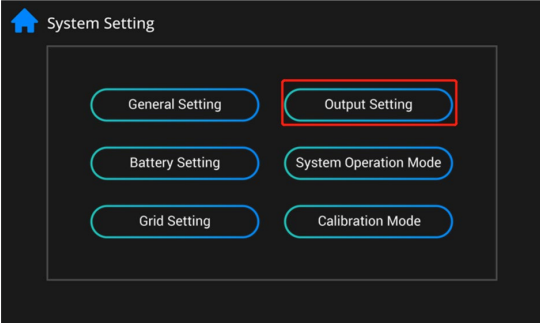
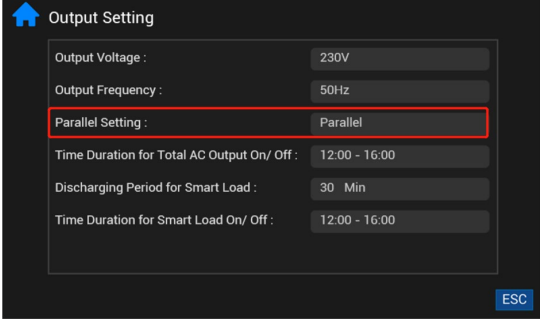
<p><b>Step 1</b></p>	
<p><b>Step 2</b></p>	
<p><b>Step 3</b></p>	

## Fault code display:

Fault Code	Fault Event
60	Power feedback protection
71	Firmware version inconsistent
72	Current sharing fault
80	CAN fault
81	Host loss

### Commissioning

Step 1: Check the following requirements before commissioning:

- Correct wire connection.
- Ensure all breakers in Line wires of load side are open and each Neutral wire of each unit is connected together.

**Step 2:** Power on each unit and set "enable parallel for output" on HMI. And then, shut down all units.

**Step 3:** Turn on each unit.

**Step 4:** Switch on all AC breakers of Line wires in AC input. It's better to have all inverters connect to utility at the same time. If not, it will display fault 82 in following-order inverters. However, these inverters will automatically restart. If detecting AC connection, they will work normally.

**Step 5:** If there is no more fault alarm, the parallel system is completely installed.

**Step 6:** Please switch on all breakers of Line wires in load side. This system will start to provide power to the load.



## Trouble shooting

Situation		Solution
Fault Code	Fault Event Description	
37	Over current on Neutral wire	<ol style="list-style-type: none"> <li>1. Remove excessive loads.</li> <li>2. Restart the inverter.</li> <li>3. If the problem remains, please contact your installer.</li> </ol>
60	Current feedback into the inverter is detected.	<ol style="list-style-type: none"> <li>4. Restart the inverter.</li> <li>5. Check if L1/L2/L3/N cables are not connected with wrong sequence in all inverters.</li> <li>6. Make sure the sharing cables are connected in all inverters.</li> <li>7. If the problem remains, please contact your installer.</li> </ol>
61	Relay board driver loss,	<ol style="list-style-type: none"> <li>1. Disconnect all of power source.</li> <li>2. Only connect AC input and press Enter key to let it working in bypass mode.</li> <li>3. Check if the problem happens again or not and feed back the result to your installer.</li> </ol>
62	Relay board communication loss,	
71	The firmware version of each inverter is not the same.	<ol style="list-style-type: none"> <li>1. Update all inverter firmware to the same version.</li> <li>2. After updating, if the problem still remains, please contact your installer.</li> </ol>
72	The output current of each inverter is different.	<ol style="list-style-type: none"> <li>1. Check if sharing cables are connected well and restart the inverter.</li> <li>2. If the problem remains, please contact your installer.</li> </ol>
80	CAN data loss	<ol style="list-style-type: none"> <li>1. Check if communication cables are connected well and restart the inverter.</li> <li>2. If the problem remains, please contact your installer.</li> </ol>
81	Host data loss	
82	Synchronization data loss	

## Appendix II: BMS

1. BMS port pin define:

	Definition
PIN 3	RS485B
PIN 5	RS485A
PIN 8	GND

2. After all wires are connected well and the communication between the inverter and battery is successful, We can check if the BMS is successfully connected on the battery interface.

<p><b>Step 1</b></p>	<p>2024-02-05-15:30 Master</p> <p>Grid, Solar, Inverter, Family load, Backup load, Smart load, Battery</p>												
<p><b>Step 2</b></p>	<p>Battery</p> <table border="1"> <tbody> <tr> <td>Battery Type :</td> <td>USE</td> </tr> <tr> <td>Status :</td> <td>CC</td> </tr> <tr> <td>SOC:</td> <td>50 %</td> </tr> <tr> <td>Battery Voltage :</td> <td>50.0 V</td> </tr> <tr> <td>Battery Current :</td> <td>60.0 A</td> </tr> <tr> <td>Power :</td> <td>3000 W</td> </tr> </tbody> </table> <p>BMS Information</p>	Battery Type :	USE	Status :	CC	SOC:	50 %	Battery Voltage :	50.0 V	Battery Current :	60.0 A	Power :	3000 W
Battery Type :	USE												
Status :	CC												
SOC:	50 %												
Battery Voltage :	50.0 V												
Battery Current :	60.0 A												
Power :	3000 W												

**Step 3**



**BMS Information**

Max Charging Voltage : 0.0 V

Max Charging Current : 0.0 A

Cut-off Voltage : 0.0 V

Max Discharging Current : 0.0 A

Status : Disconnect

# Appendix III: The Wi-Fi Operation Guide

## 1. Introduction

Wi-Fi module can enable wireless communication between solar inverters and the monitoring platform. Users can remotely monitor and control their inverters when they combine the Wi-Fi module with i.Solar APP. The App uses the Wi-Fi chip to provide remote monitoring data services, which is beneficial for the daily data monitoring of the inverter, querying the real-time data in the device, sending commands from the device, and operating the device remotely. The app is available for both iOS and Android.

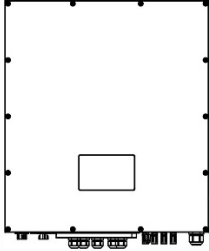

## 2. i.Solar App

### 2-1. APP Download and Installation

#### *Operating system requirement for your smart phone:*

 iOS system supports iOS 12.0 and above

 Android system supports Android 10.0 and above



You may find "i.Solar" app from the Apple® Store and Google® Play Store.

## 2-2. WiFi Model Setting

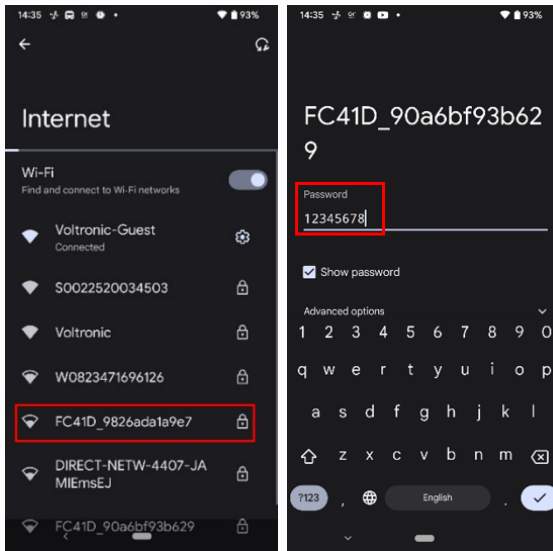

Step 1: Turn on your mobile device. This example uses the Android system.

Step 2: Open the mobile's Wi-Fi settings

Step 3: Connect your device to the Wi-Fi with the name that begins with "FC41D\_". The default password for this Wi-Fi is **12345678**.

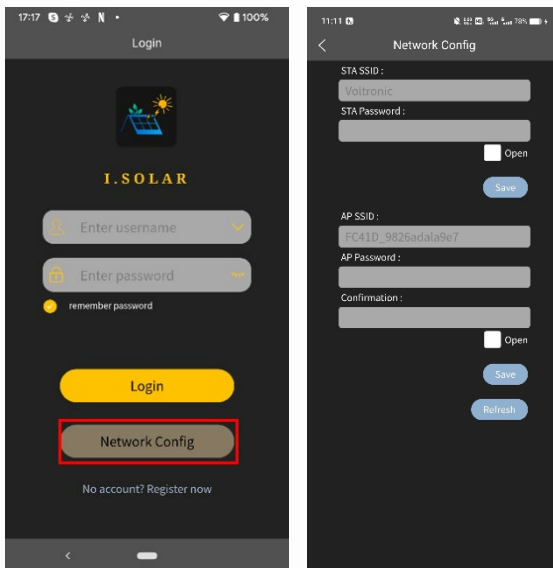

Step 4: After the Wi-Fi connection is successful, click the i.Solar App installed on the phone to enter the login page. Then, click the "Network Config" button to enter the Wi-Fi configuration page.

Step 5: After click the "Network Config" button to enter the Wi-Fi configuration page.

Step 6: Enter your router name (STA SSID) and router password (STA Password), then click the "Save" button to complete the setting.

If you check the "Open" box marked in red, you only need to enter the router name (STA SSID), you don't need to enter the router password. Click the "Save" button to complete the setting.

Step 7: Enter the Wi-Fi name (AP SSID) and Wi-Fi password (AP Password) of the Wi-Fi card, confirm the password again and click the "Save" button to complete the setting of the Wi-Fi module.

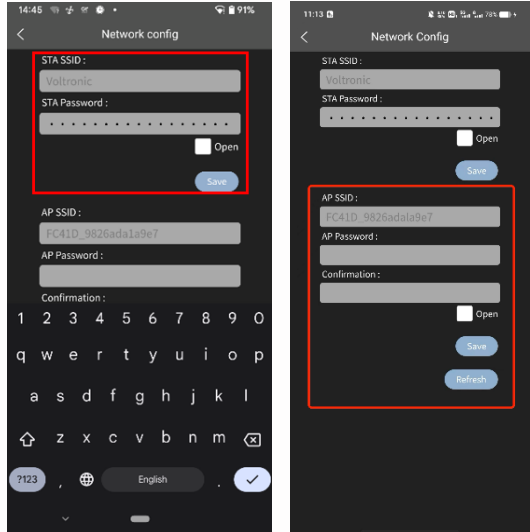

If you check "Open" marked in red, you only need to enter the Wi-Fi name (AP SSID), you don't need to enter the Wi-Fi password and Confirmation. Click the "Save" button to complete the setting.

Step 8: After entering the value of the baud rate, click the "Save" button to complete the setting of Uart Baud Rate.

## 2-3. Login

After opening the app, enter the login page shown below. After filling in all required information (user name and password), click the "Register" button to complete the user registration. Once registration is complete, click "Click to log in" or return to the previous page. Swipe left or click the left arrow to return to the login page. Enter the user name and password to log in.

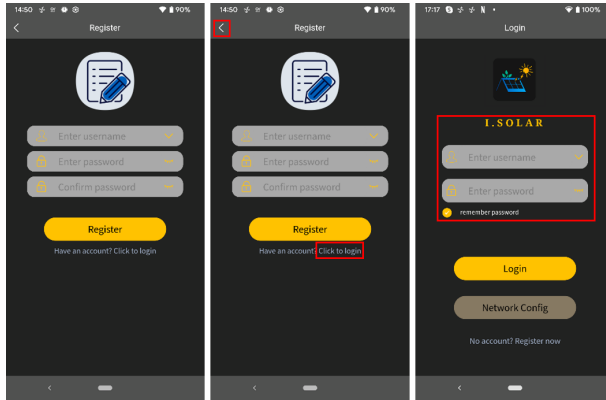

## 2-4. Home Page

Log in to enter the App. The default Home page will appear where you can view the charts (left screenshot). Click the button 'Day', 'Month', and 'Year' to query the power generation data. Click 'Total' to query the annual power generation data.

Tap the icon (located on the top right corner) to enter the page to add, delete or rename the device. Enter the device serial number to add the device.

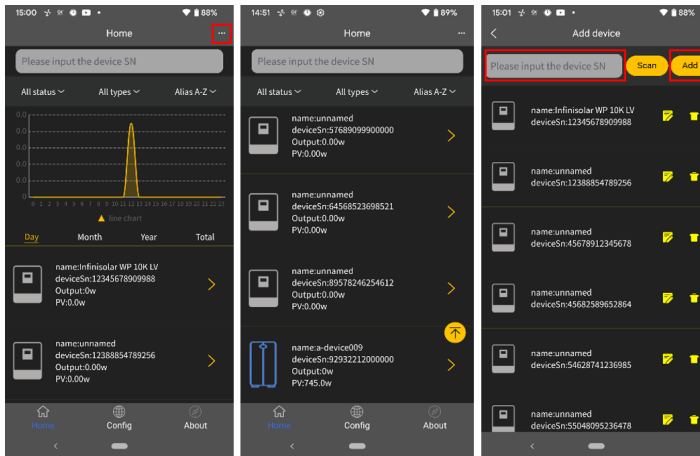

Rename (left screenshot) and delete (right) the devices by pressing the buttons highlighted by the red box.

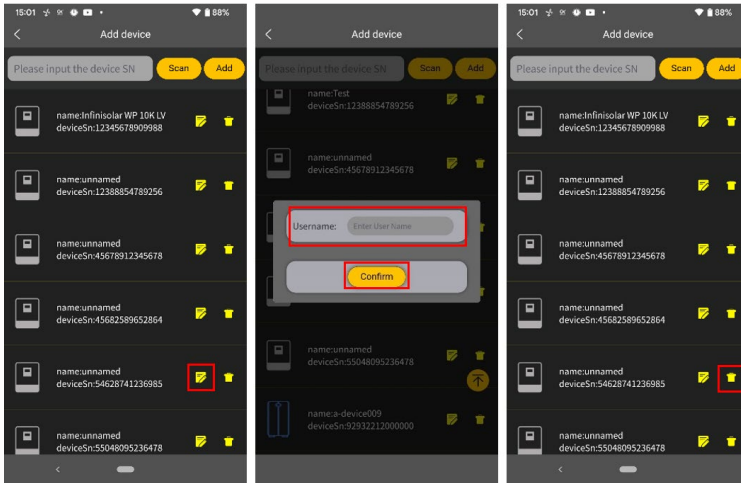

## 2-5. Real-time Data

'Energy' displays battery power, grid power, solar power, and load consumption. Rename the device by pressing the 'Rename' button.

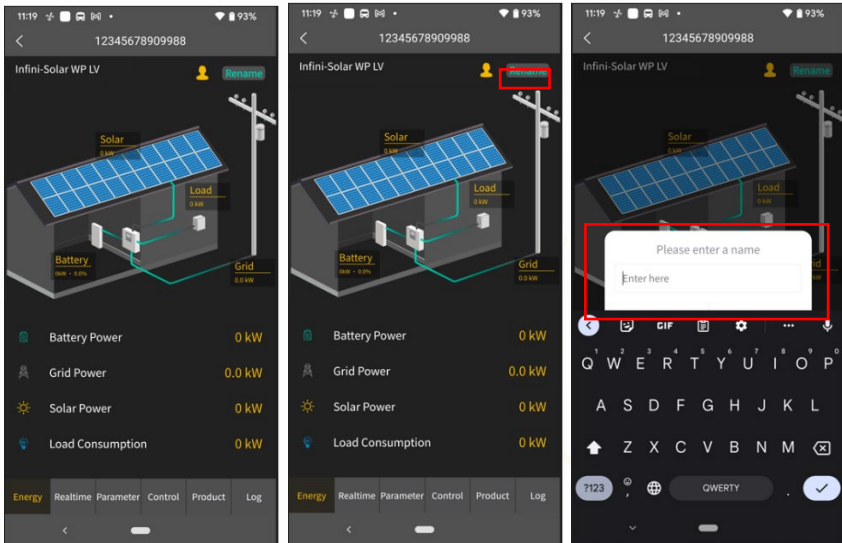

'Real-time' displays solar, grid, load, and battery information. Press 'Day', 'Month', or 'Year' to query the hourly, daily, or monthly power generation data. Press 'Total' to query the annual power generation data.



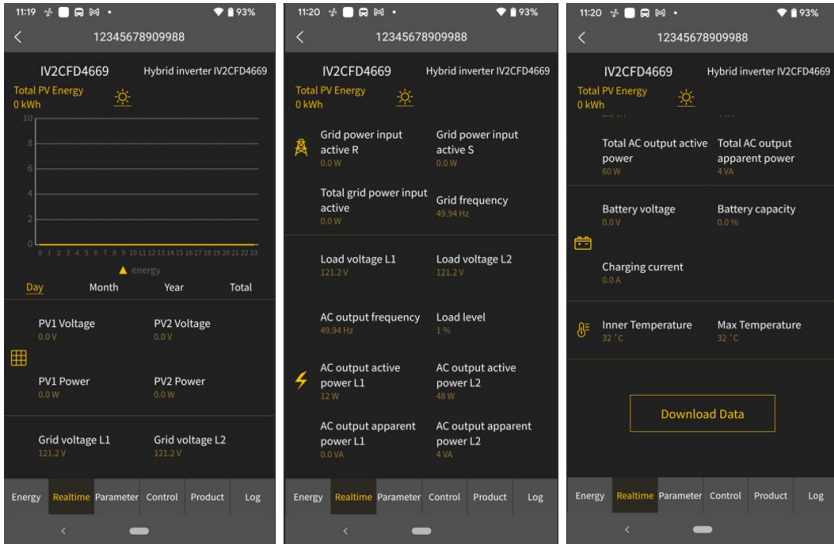

'Parameter' displays the setting items. Note that the setting items on the parameter page will be different for different models. Tap on the dropdown icon to select the setting and click the "Apply" button to change the setting

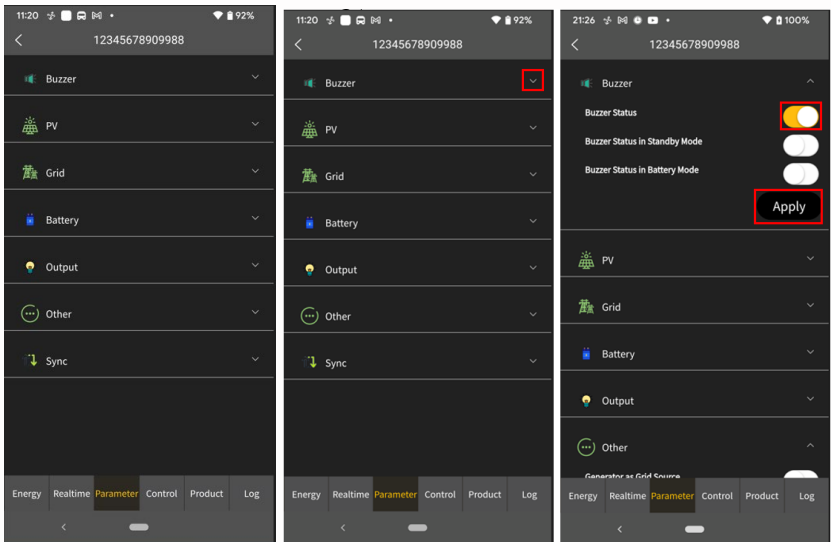

'Control' displays the power on/off for AC output power. 'Product' displays the product and rating information (right screenshot).

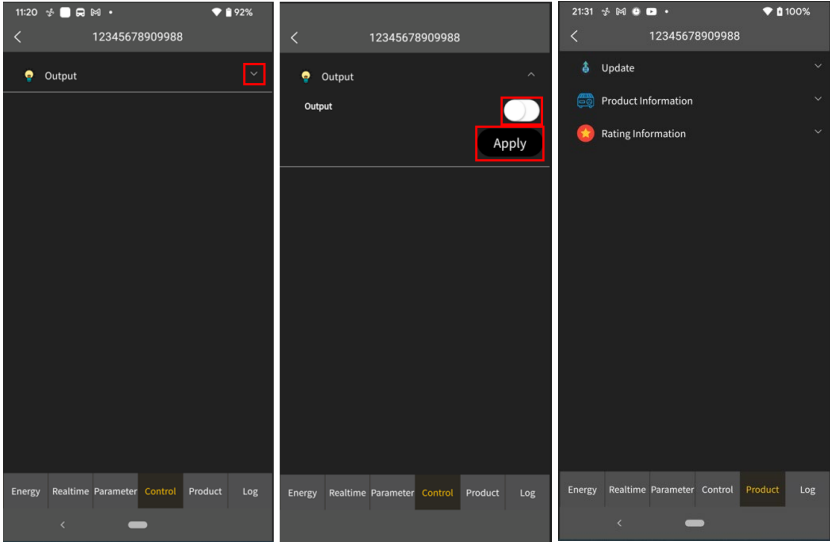

'Log' displays the data log, solar power generation log and event. The following are instructions on how to navigate through each of the options.

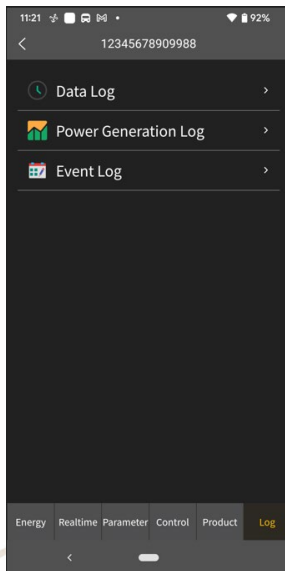

## Data log

Tap the time, select the date and click the "Browse" button to update log.

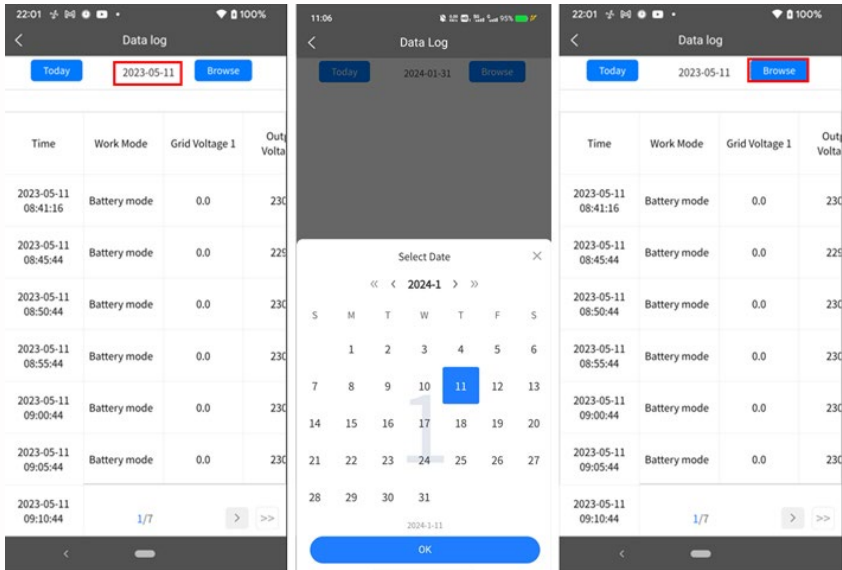

## Power Generation Log

Tap the time, select the day, month or year, and click the "Done" button to update log.

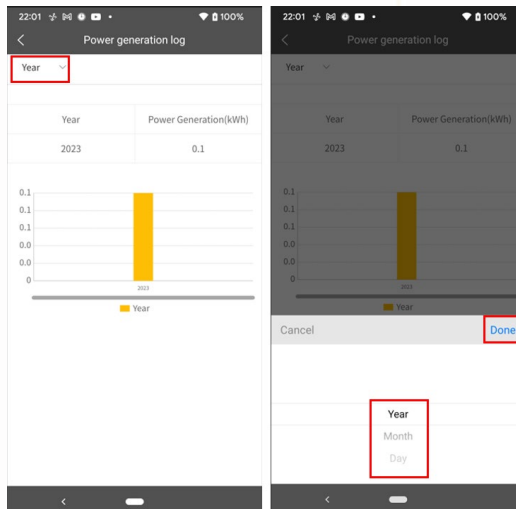

## Event Log

Tap the time, select the month and click the "Browse" button to update log.

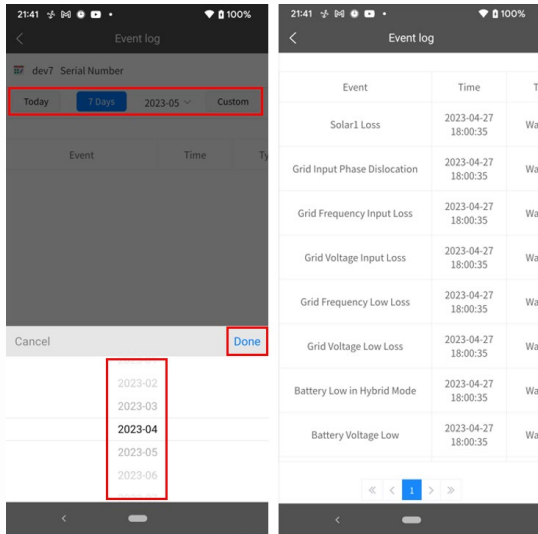

Click the "Custom" and it will show time duration list. Select the date and click the "Browse" button to update log.

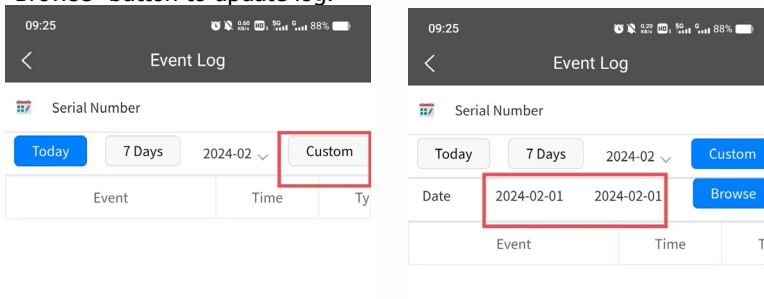

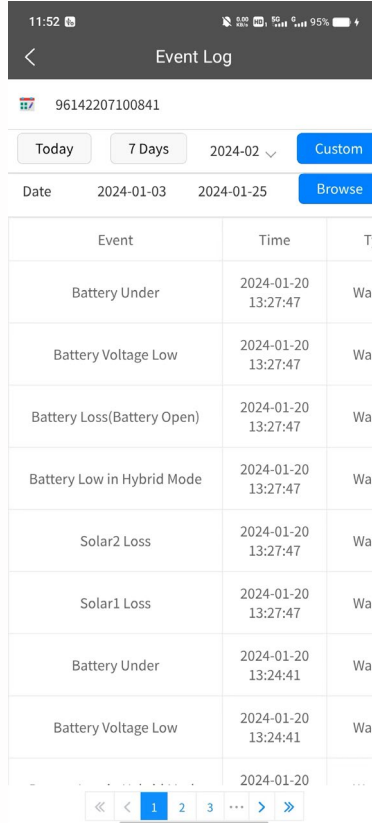
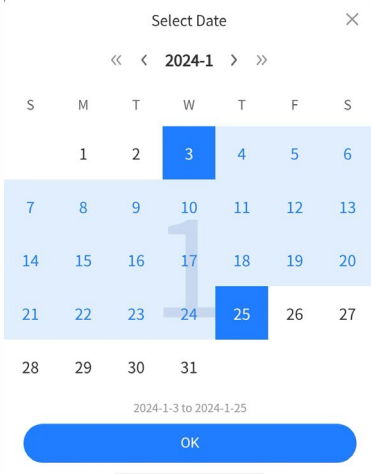
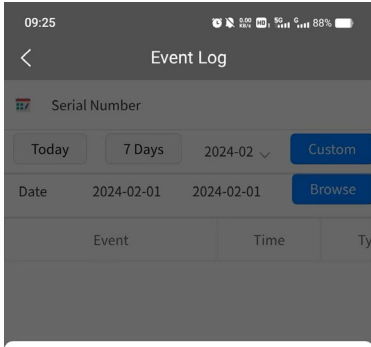

## 2-6. Configuration

Click the "Config" tab to enter setting screen. 'Change Password' by entering the old password, entering the new password, confirming the new password, and clicking the Apply button to complete the password modification function. 'Delete Account' by pressing delete account.

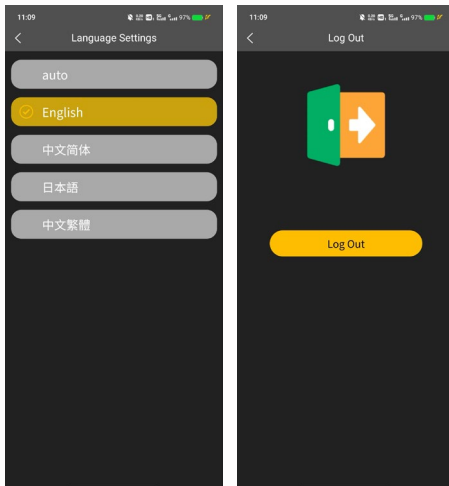
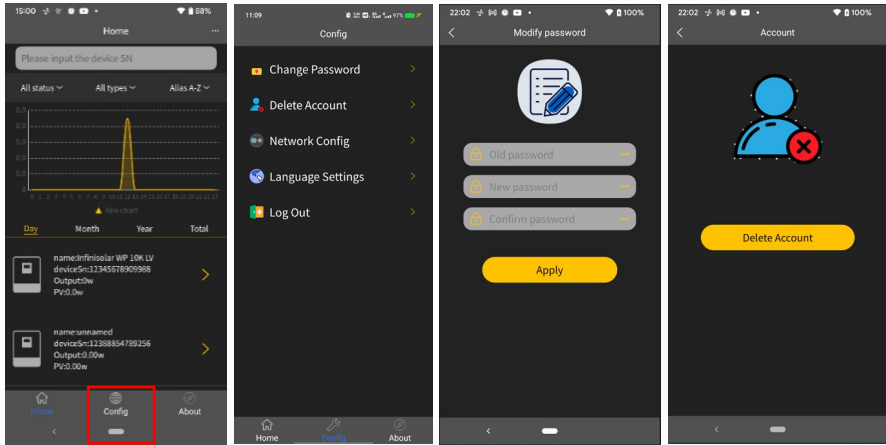

## 2-7. About

Click the 'About' tab to enter the about page, where you can view the information about the App.

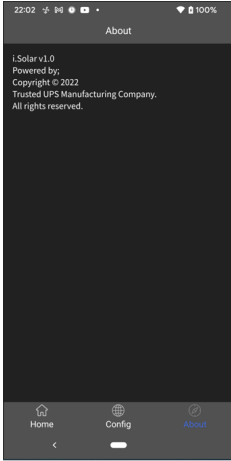

### 3. OTA Operation

**NOTE△: The inverter output should be turned off during updating.**

#### Preparations

- The inverter is online;
- Contact the supplier to obtain the password;
- Contact the supplier to upload the firmware;
- Be sure to maintain good network conditions during updating.

1. Click the ">" icon circled in red to enter the corresponding inverter screen.

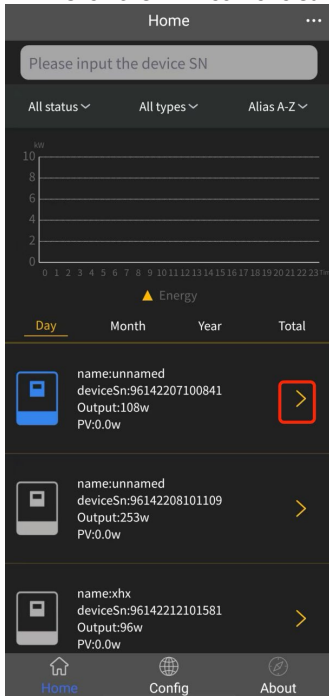

2. Click the "Product" button marked in red square in Figure 1 to enter the Product Screen, as shown in Figure 2.



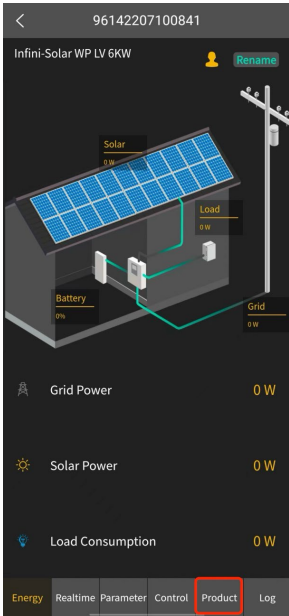

Figure 1

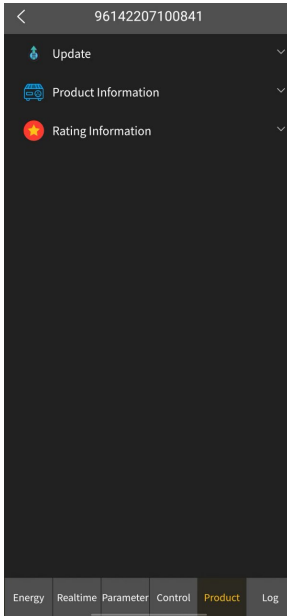

Figure 2

3. Click the "v" icon marked in red on the right side of the "Update" in Figure 1 to open the collapsible panel, as shown in Figure 2.

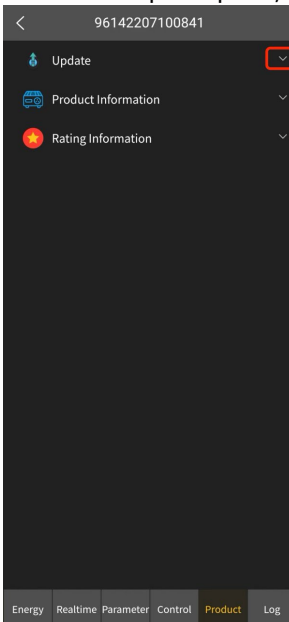

Figure 1

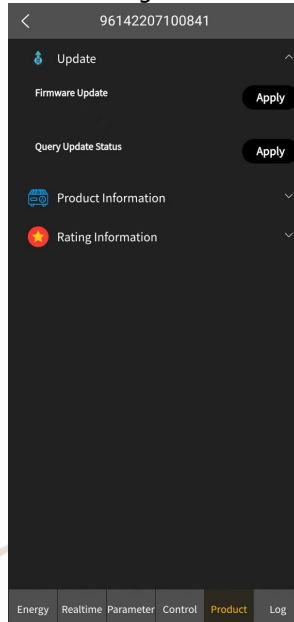
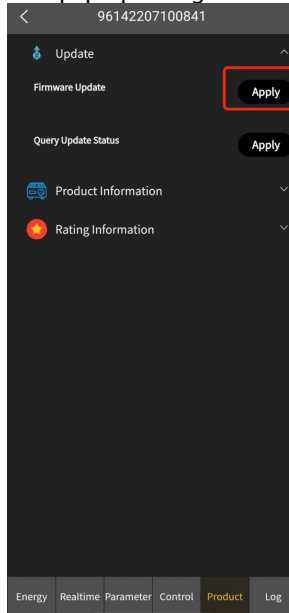
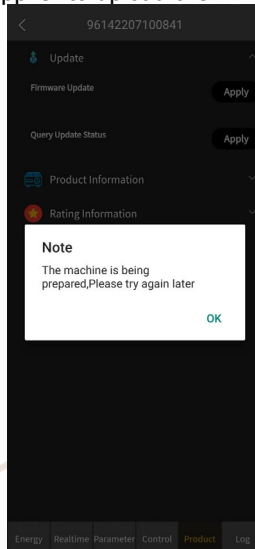

Figure 2

4. Click the "Apply" button marked in red on the right side of the "Firmware Update" in below figure to call an update pop-up dialog.



- (1) If the inverter does not upload the firmware, a warning dialog will pop up. Please contact the supplier to upload the firmware.



- (2) For the first update, the update pop-up dialog is shown below.

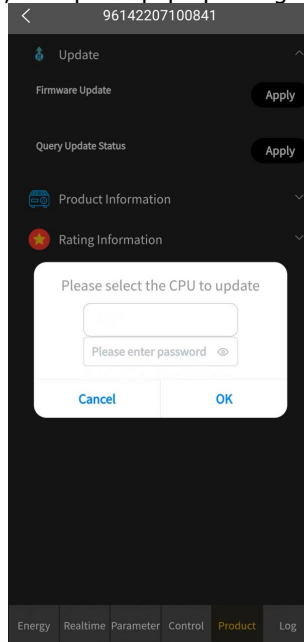

- (3) If not the first update, the last updated CPU will be indicated at the location circled in red.

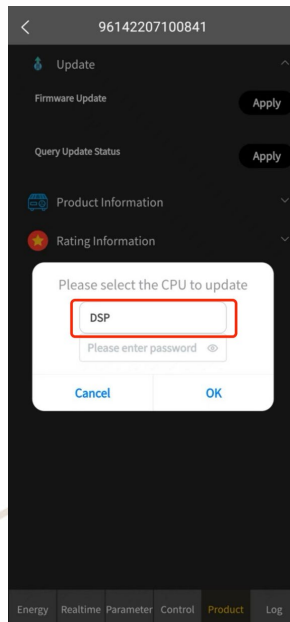

5. Click the selection box circled in red in Figure 1 to call the drop-down box option. Select the CPU to be updated. In the example shown in Figure 2, DSP is selected.

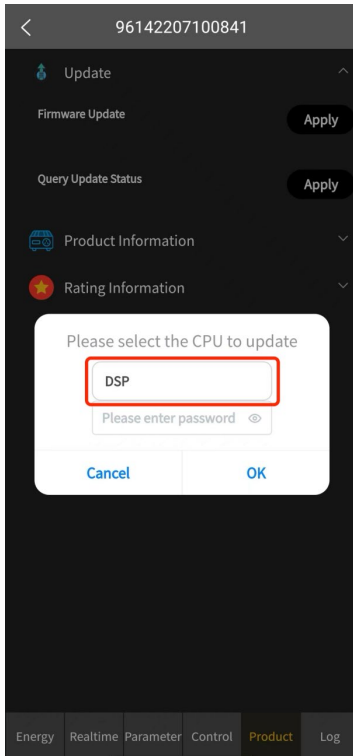

Figure 1

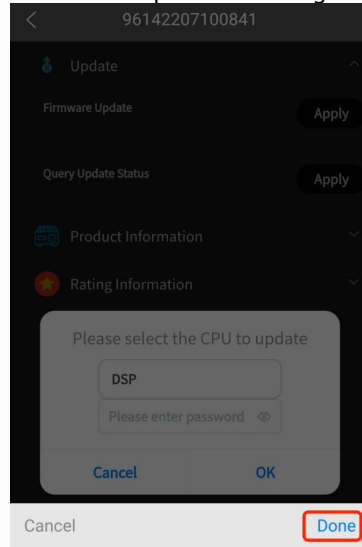
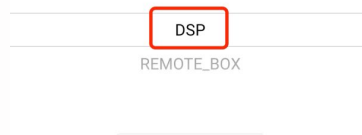

Figure 2

6. Enter the password provided by the supplier in the input field and then click "OK". The dialog "Send update command success" will pop up, as shown in Figure 2. The firmware will start updating. Please wait until it is successfully updated. (Be sure to maintain good network conditions and ensure that the inverter is powered on, during updating.)



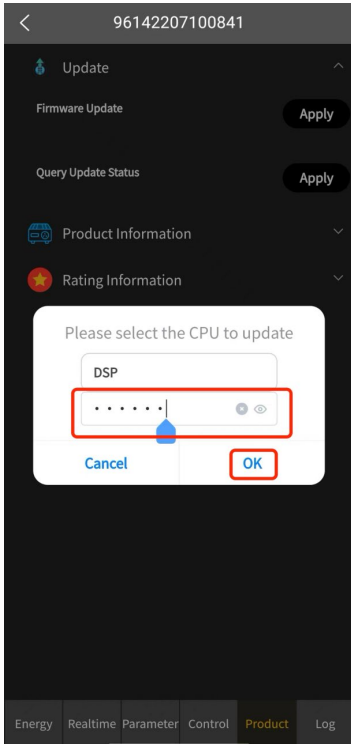

Figure 1

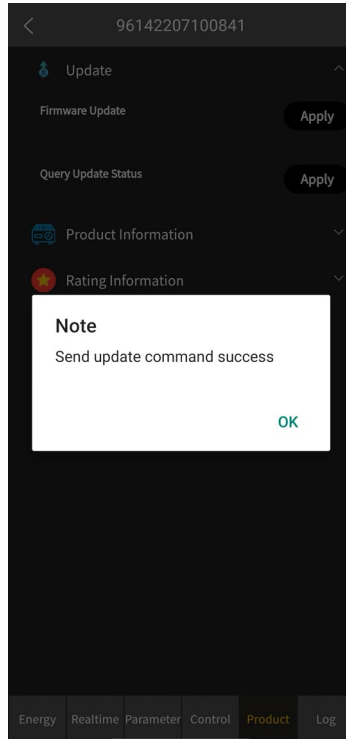

Figure 2

7. Click the "Apply" button circled in red on the right side of the "Query Update Status" in Figure 1 to enter the Query Screen and search for the last update result.
- (1) If the inverter is updating, the query result will be like that shown in Figure 2.

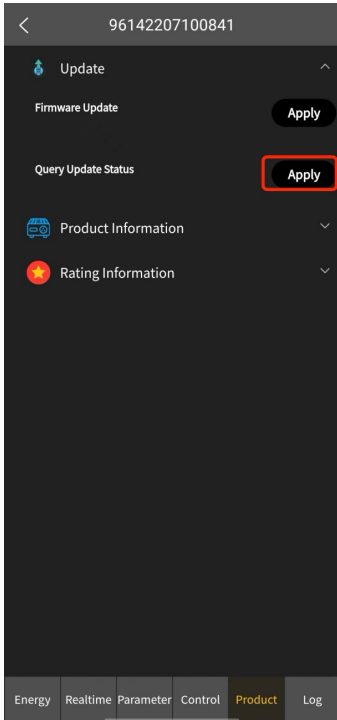

Figure 1

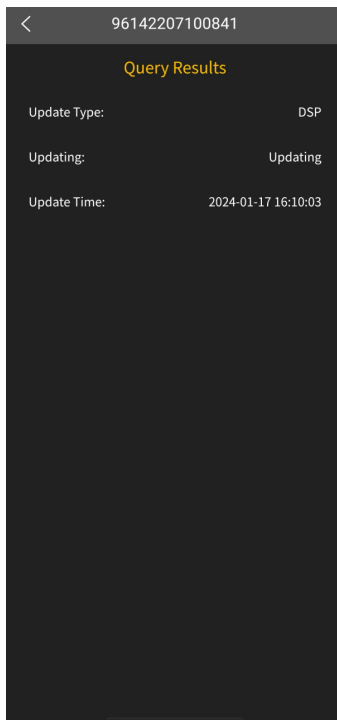
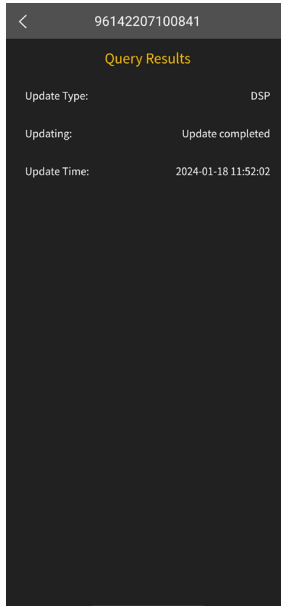
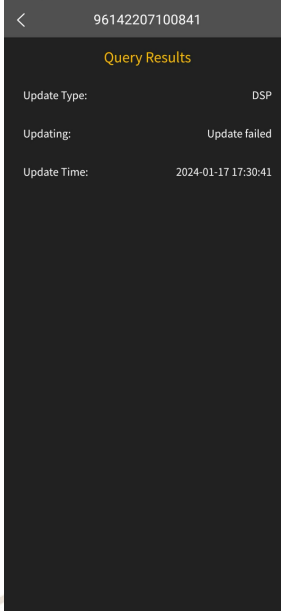

Figure 2

(2) If the inverter is successfully updated, the query result will be like that shown below.



(3) If the inverter update fails, the query result will be like that shown below.



## 8. Glossary:

The terms "Before Updating" and "During Updating" are defined as follows for the troubleshooting purpose:

- The status is "Before Updating" before the following dialog pops up.
- The status is "During Updating" after the following dialog pops up.

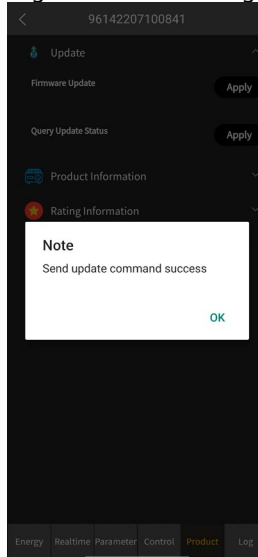

## 9. Troubleshooting:

Fault 1: After you click the "Apply" button circled in red on the right side of the "Firmware Update" in Figure 1, the warning dialog "The machine is being prepared. Please try again later." pops up.

Causes:

- (1) The inverter has been powered off before updating.
- (2) The inverter fails to upload the firmware.
- (3) The inverter becomes off-line before updating.

Solutions:

- (1) Check whether the inverter is powered on. Power it on again and then repeats Steps 4 to 7.
- (2) Contact the supplier to upload the firmware.
- (3) Check the network status of the inverter. Reconnect the inverter to the network and then repeat Steps 4 to 7.



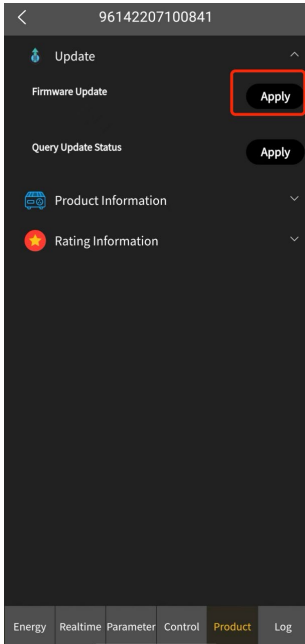

Figure 1

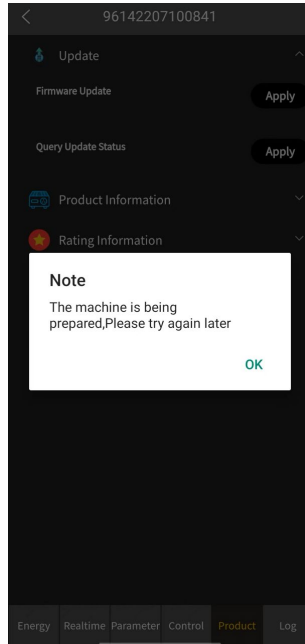

Figure 2

**Fault 2:** After you click the "Apply" button circled in red on the right side of the "Firmware Update" in Figure 1, or the "Apply" button circled in red on the right side of the "Query Update Status" in Figure 2, there is no any response on the screen.

**Causes:**

- (1) The mobile phone becomes off-line.

**Solutions:**

- (1) Check the network status of the mobile phone and then reconnect it to the network.

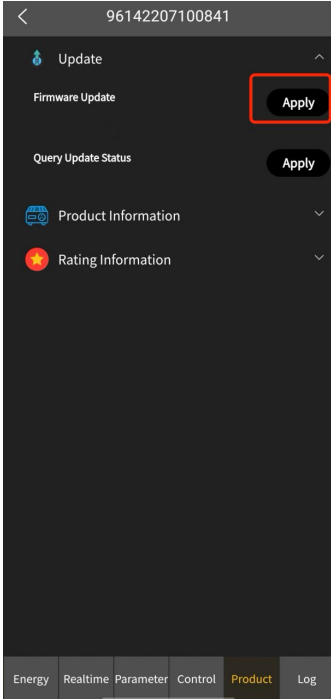

Figure 1

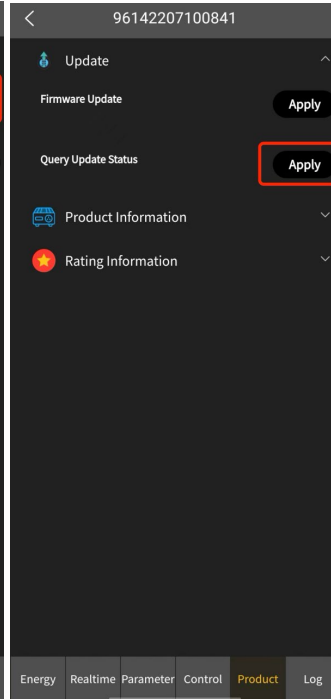

Figure 2

Fault 3: On the Query Screen of update results, "Update failed" is displayed in the "Updating" column.

Causes:

- (1) The inverter has been powered off during updating.
- (2) The inverter becomes off-line during updating.

Solutions:

- (1) Check whether the inverter is powered on. Power it on again and then repeats Steps 4 to 7. Alternatively, contact the supplier for a solution.
- (2) Check the network status of the inverter. Reconnect the inverter to the network and then repeat Steps 4 to 7. Alternatively, contact the supplier for a solution.

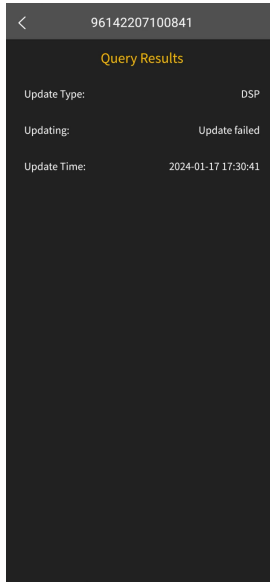

Fault 4: The inverter has been updated (the dialog "Send update command success" pops up). When you view the "Update Time" on the Query Screen of update results after 30 min, no log for the present update is displayed. Example: For the first update, the pop-up dialog is shown below (Figure 1). If not the first update, the last update log will be displayed, as shown in Figure 2.

Causes:

- (1) The inverter has been powered off before or during updating.
- (2) The inverter becomes off-line during updating.

Solutions:

- (1) Check whether the inverter is powered on. Power it on again and then repeats Steps 4 to 7.
- (2) Check the network status of the inverter. Reconnect the inverter to the network. Wait for 30 min until the inverter is successfully updated. Check whether the inverter is online. If yes, it indicates that the inverter has been successfully updated. If the inverter is off-line, please check whether the inverter has been reconnected to the network. Alternatively, contact the supplier for a solution.

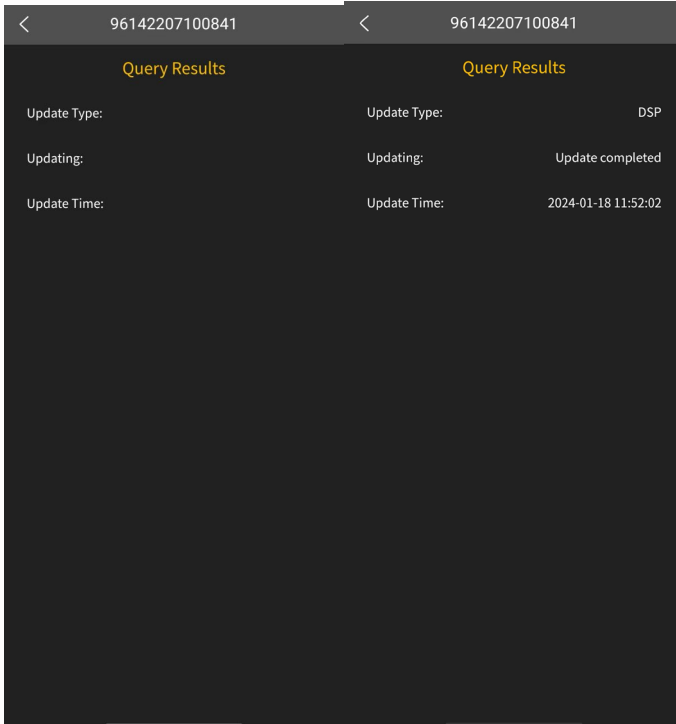

Figure 1

Figure 2

Fault 5: The inverter has been updated (the dialog "Send update command success" pops up). After 30 min, the inverter is always off-line.

Causes:

- (1) The inverter has been powered off during updating.
- (2) The inverter becomes off-line during updating.

Solutions:

- (1) Check whether the inverter is powered on. Power it on again. If it is online, repeat Steps 4 to 7. If it is still off-line, please contact the supplier for a solution.
- (2) Check the network status of the inverter. Reconnect the inverter to the network. Wait for 30 min until the inverter is successfully updated. Check whether the inverter is online. If yes, it indicates that the inverter has been successfully updated. If the inverter is off-line, please check whether the inverter has been reconnected to the network. Alternatively, contact the supplier for a solution.

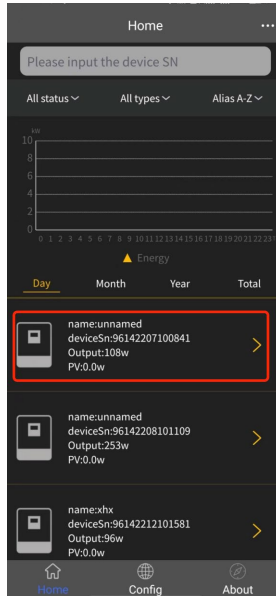

**Fault 6:** When you view the "Update Time" shown below on the Query Screen of update results, the "Updating" is always displayed.

**Causes:**

- (1) The inverter has been powered off during updating.
- (2) The inverter becomes off-line during updating.

**Solutions:**

- (1) Check whether the inverter is powered on. Power it on again and then repeats Steps 4 to 7. Alternatively, contact the supplier for a solution.
- (3) Check the network status of the inverter. Reconnect the inverter to the network. Repeat Steps 4 to 7. Alternatively, contact the supplier for a solution.

