

MOTOMA®

Power into the Future

USER MANUAL



25.6V	100Ah/150Ah/200Ah
48V	100Ah/150Ah/200Ah
51.2V	100Ah/150Ah/200Ah/300Ah

Table Of Contents

1 Introduction	4
2 Safety Warning	5
2.1 Before Connecting	5
2.2 During Operation	5
3 Unpacking & Overview	6
3.1 Packing List	6
4 Product Overview	7
4.1 General Battery Shape	7
4.2 Combiner Box	8
5 Installation	9
5.1 Selecting Mounting Location	9
5.2 Mounting The Battery	10
6 Error Code Information	22
7 Host Soft Operation	23
8 Trouble Shooting	24
8.1 Emergency Process	26
8.1.1 The External Device Catches Fire And Explodes	26
8.1.2 The Battery Catches Fire And Explodes	26

Figure 1 Energy Storage System Overview	4
Figure 2 Front View & Top View	7
Figure 3.1 Breaker	8
Figure 3.2 Breaker	8
Figure 3.3 Breaker	9
Figure 4 Mount Distance	10
Figure 5 Drill Hole	11
Figure 6 Tighten Screws	11
Figure 7 Mount Bracket	11
Figure 8 More Battery Packs	12
Figure 9 Batteries in Parallel	12
Figure 10 Connection Between 1pc Inverter and 1pc Battery	13
Figure 11 Connection Between 1pc Inverter and 2pcs Batteries	13
Figure 12 Connection Between 1pc Inverter and 2pcs Batteries Bottom View	13
Figure 13 Connection Between 1pc Inverter and 3pcs Batteries	14
Figure 14 Connection Between 1pc Inverter and 3pcs Batteries Bottom View	14
Figure 15 Connection Between 3pcs Inverters and 3pcs Batteries Bottom View	14
Figure 16 Dial Address	15
Figure 17 Dry Contact	15
Figure 18 RS485 and CAN Port	16
Figure 19 Reset Battery	16
Figure 20 LED	18
Figure 21 Button and LCD	20
Figure 22 Main Menu	20
Figure 23 Main Parameters	20
Figure 24 Battery Status	21
Figure 25 Baud Rate	21
Figure 26 File Location	22
Figure 27 Main Window	22
Figure 28 Reset for Trouble Shooting	23

1 Introduction

The energy storage battery is an essential component of the PV power generation system. It can provide electricity power for the connected loads, and it can also store the electricity power from PV modules, diesel generators, or wind energy generators. When the sun goes down, energy demand is high, or there is a power outage, you can use the energy stored in the system to meet your energy needs at no additional cost. In addition, the Energy storage battery can help you achieve energy self-consumption and ultimately achieve the goal of energy independence.

According to different power consumption, the Energy storage battery can output power during peak power consumption, and can also store energy during low power consumption. Therefore, the PV arrays and inverter are required to match the battery to achieve the highest operating efficiency. For a simple diagram of a typical energy storage system, see Figure 1.

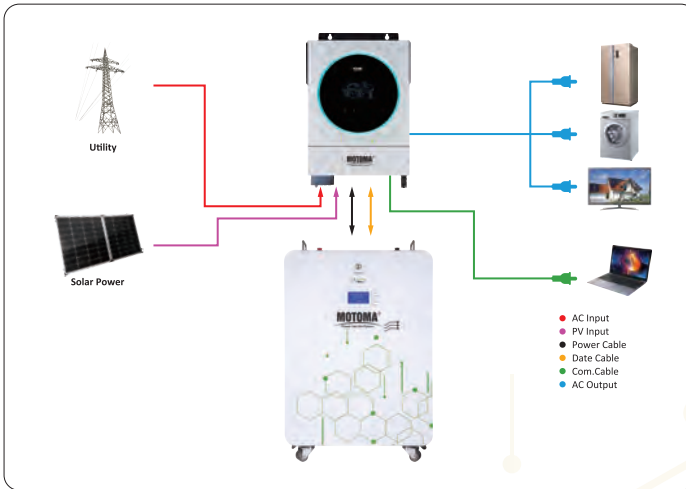

Figure 1 Energy Storage System Overview

- It is very important and necessary to read the user manual carefully before installing or using the battery. Failure to follow any of the instructions or warnings in this document can result in electrical shock, serious injury, death, or may damage the battery and the whole system.
- If the battery is stored for a prolonged time, it is requirement that they are charged every three to six months, and the SOC should be no less than 80%, after fully discharging, The battery needs to be recharged within 12 hours.
- Do not expose cable outside. Do not use cleaning solvents to clean the battery.
- All battery terminals must be disconnected before maintenance.

2 Safety Warning

- Do not expose the battery to flammable or harsh chemicals or vapors.
- Do not paint any part of the battery; include any internal or external components.
- Do not connect battery with PV solar wiring directly.
- Any external object is prohibited to be inserted into any part of the battery.
- Any warranty claims are excluded for direct or indirect damage due to items above.
- Parallel connection within 10 batteries, the maximum 15 batteries, Series connection is NOT allowed.

2.1 Before Connecting

- After unpacking, please check the battery and packing list first, if the battery is damaged or spare parts are missing, Please contact the dealer.
- Before installation, be sure to cut off the grid power and make sure the battery is in the turned off mode.
- Wiring must be correct, do not mix-connect the positive and negative cables, and ensure no short circuit with the external device.
- It is prohibited to connect the battery with AC power directly.
- The BMS in the battery is designed for 24 VDC / 48 VDC, DO NOT connect battery in series.
- It is prohibited to connect the battery with different type of batteries.
- Please ensure the electrical parameters of battery system are compatible to inverter.
- Keep the battery away from fire or water.

2.2 During Operation

- If the battery system needs to be moved or repaired, the power must be cut off first and the battery is completely shutdown.
- It is prohibited to connect the battery with different type of battery.
- It is prohibited to put the batteries working with faulty or incompatible inverter.
- In case of fire, only dry powder fire extinguisher can be used, liquid fire extinguishers are prohibited.
- Please do not open, repair or disassemble the battery. We do not undertake any consequences or related responsibility due to violation of safety operation or violating of design, production and equipment safety standards.

3 Unpacking & Overview

3.1 Packing List

You will receive the following parts (Not a full set), sample as follow picture. For customized requirements, please place an order with the manufacturer.

Battery pack 	Power output positive cable 	Power output Negative cable 
Inverter COM. cable 	Parallel COM. cable (RJ45) 	Manual 
Mounting brackets 	Mounting frame screw 	Flat-head screws 
*Combiner box 	*Combiner out-cable 	*Combiner out-cable 
*RS232 COM. box 	*RS485 COM. box 	*CAN COM. box 

*NOTE: * Types of communication tools need to place an order.

4 Product Overview

4.1 General Battery Shape

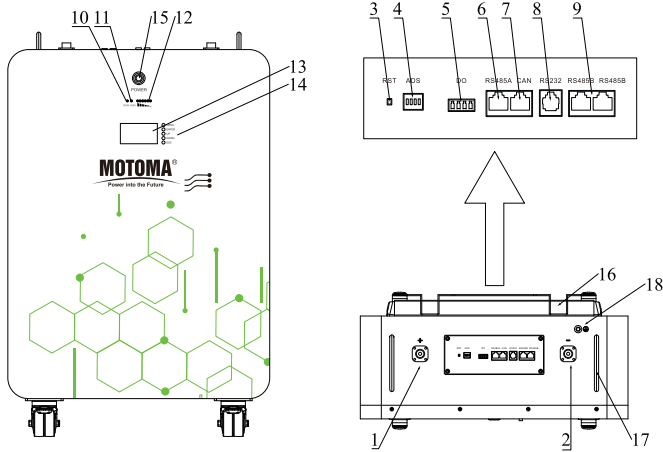

Figure 2 Front View & Top view

No.	Description	Silk-screen	Remark
1	Battery positive pole	P+	Output terminal
2	Battery negative pole	P-	Output terminal
3	Reset	RST	
4	ADS Coder	ADS	Set Battery address code
5	DRY connect port	DO	
6	485A communication port	RS485A	Connect to inverter
7	CAN communication port	CAN	Connect to inverter
8	RS232 communication port	RS232	Host software
9	RS485B communication port	RS485B	Parallel use
10	Run LED indication	RUN	
11	ALARM LED indication	ALM	
12	Capacity LED indication		
13	LCD		
14	LCD key		
15	Power switch	ON/OFF	
16	Fixed bracket		
17	Handle		
18	GND		

4.2 Combiner Box



If current is small around 100A, could use the Breaker (Figure 3.1).

If the current is higher than 150A, could use the breaker (Figure 3.2).

NOTE: Breaker value should be 20% more than actual current.



Figure 3.1 Breaker



Figure 3.2 Breaker

For using " Fuse"

Like breaker you can use fuse also ,But the fuse is unrecoverable when was blown and need to change to new one.

NOTE: Fuse value should be 10% more than actual current.



Figure 3.3 Breaker

5 Installation

5.1 Selecting Mounting Location

Consider the following points to install the Energy storage battery:

- Do not mount the battery on flammable wall. Mount on a solid wall.
- Install this battery at eye level in order to allow the readability of LCD display at all times.
- For proper air circulation to dissipate heat, please leave a gap of about >30cm from the ground, 30 cm from the side of the device.
- The ambient temperature should be between 0°C and 40°C and relative humidity should be between 25% and 85% to ensure optimal operation.
- The recommended installation is vertical adherence.
- Install the battery in a dry, protected area with no excessive dust and sufficient air circulation. Do not operate in locations where the temperature and humidity are out of the specified range.

5.2 Mounting the Battery

WARNING!! Remember that the Battery is heavy so please be careful when removing it from the package, or install it.

When installing the Battery bracket, use appropriate screws to fix it. After that, the equipment should be firmly bolted. The Battery can be run indoors or outdoors. However, only professional personnel can enter this area for installation or maintenance.

Step 1:

When receiving the product, first check whether all parts is complete, if not, please report to the Dealer.

Step 2:

Ensure that the Battery is installed on the solid wall. Choose a suitable installation location and require the battery to be placed at a safe distance over 30cm from the ground, and the safety distance between battery packs is also over 30cm. We recommend an installation distance is 50cm.

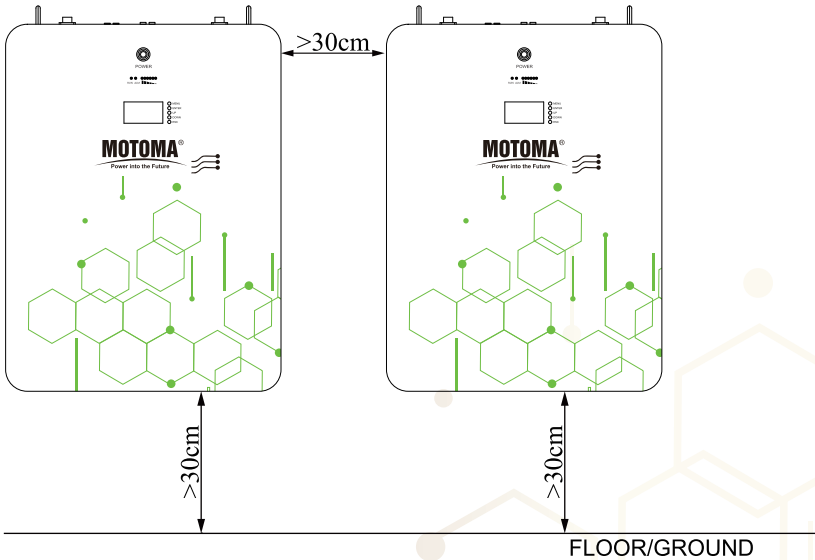

Figure 4 Mount Distance

Step 3:

Use the mounting bracket to mark the location of the positioning screw hole on the wall, and drill the hole. See Figure 5 & 6. Need to be drilled with a drill of appropriate diameter.

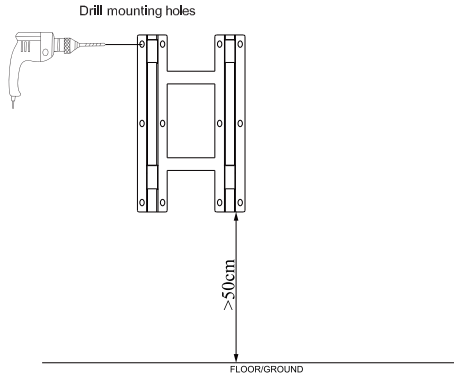

Figure 5 Drill Hole

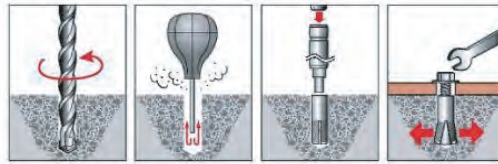

Figure 6 Tighten Screw

Step 4:

Insert frame screws, then place the bracket, and use screws lock it.

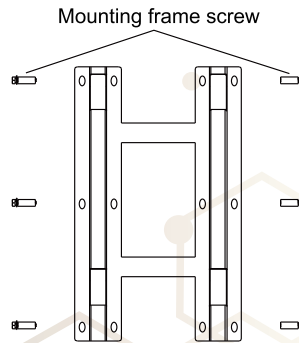

Figure 7 Mount Bracket

Step 5:

As below figure, install the battery pack. The battery is too heavy. Please use a special lifting device to lift the battery for operation and safety protection. Lift the battery and put it into the slot of the fixing bracket from the front.

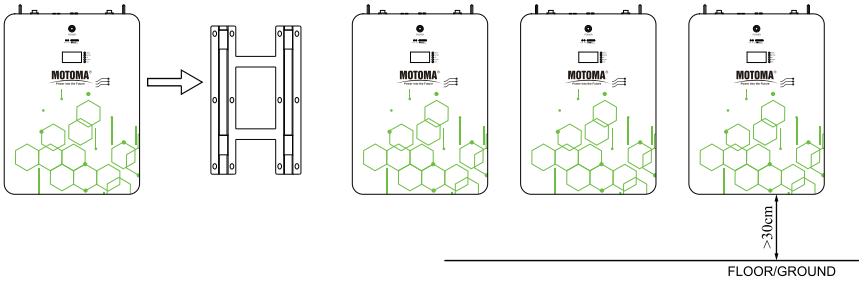

Figure 8 More Battery Packs

Step 6:

When more than 3PCS batteries are connected in parallel, we recommend to install the combiner box. Better in Top or Bottom location.

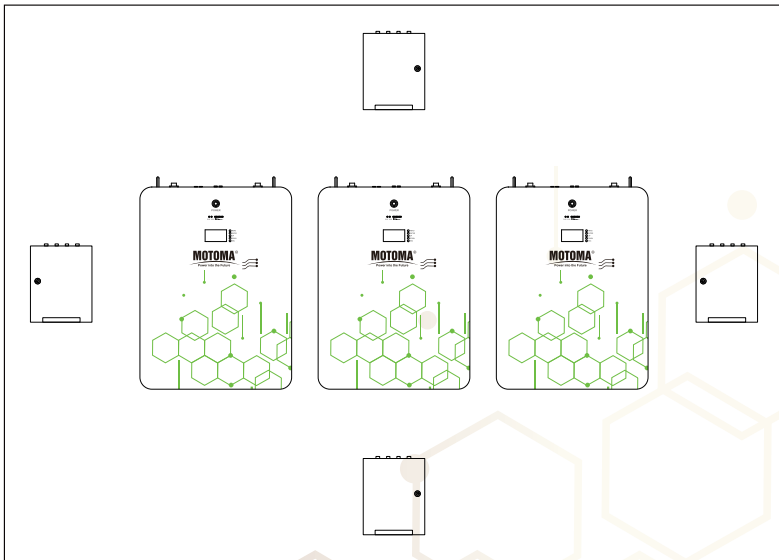

Figure 9 Batteries in Parallel

Step 7:

Connection as below. See figure 10. If inverter needs CAN BUS port /RS485 port. Please insert communication cable (RJ45) to CAN port or RS485A, RS485B only be used for battery packs parallel mode.

- 1 Battery, 1 Inverter. Single mode.

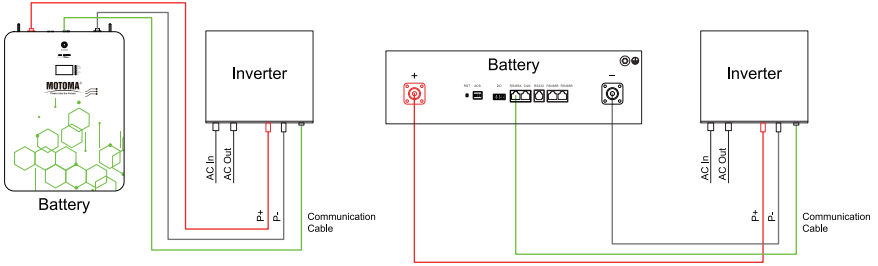

Figure 10 Connection Between 1pc Inverter and 1pc Battery

- 2 Batteries---1 Inverter. Battery 1 is slave. Battery 2 is master.
Negative and Positive power cable are the same length.

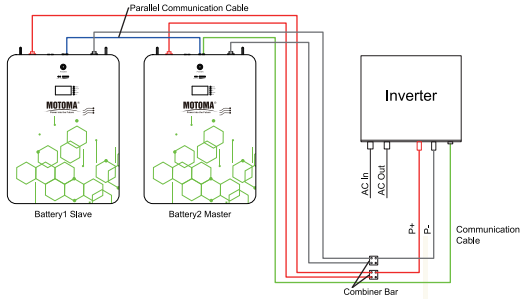

Figure 11 Connection Between 1pc Inverter and 2pcs Batteries

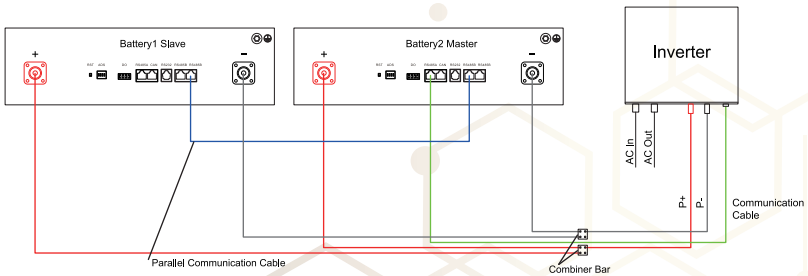

Figure 12 Connection Between 1pc Inverter and 2pcs Batteries Bottom View

- 3 Batteries---1 Inverter. Battery 1, 2 is slave. Battery 3 is master.

More batteries in parallel, one battery is master, others are slave. Negative and Positive power cables are the same.

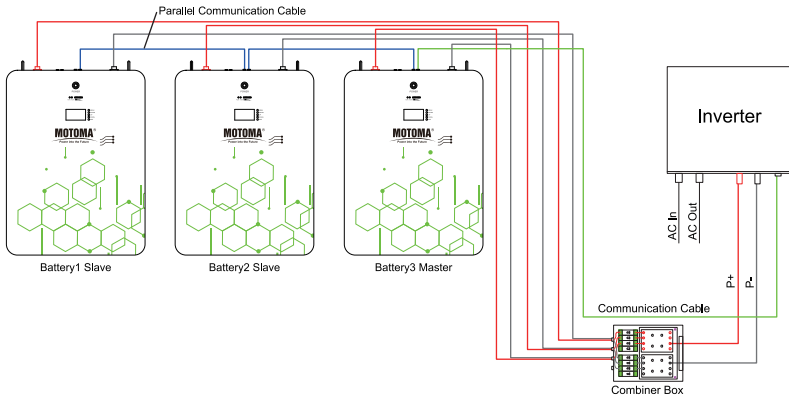

Figure 13 Connection Between 1pc Inverter and 3pcs Batteries

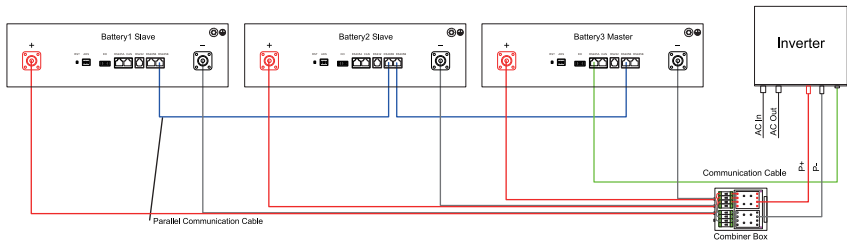

Figure 14 Connection Between 1pc Inverter and 3pcs Batteries Bottom View

- 3 Batteries---3 Inverters.

Mainly cable for 3-phase inverter. battery 1, 2 is slave. Battery 3 is master. More batteries in parallel, one pack is master, other are slave. 3-phase inverter output 380V AC. One inverter is master, others are slave. Please refer to the operation manual of the corresponding inverter for the parallel connection method of the inverter, here is only an example.

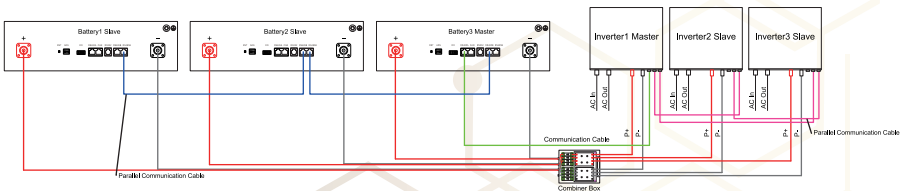

Figure 15 Connection Between 3pcs Inverters and 3pcs Batteries Bottom View

Step 8:

Set the battery address, there are 4 bit coders in bottom of battery.

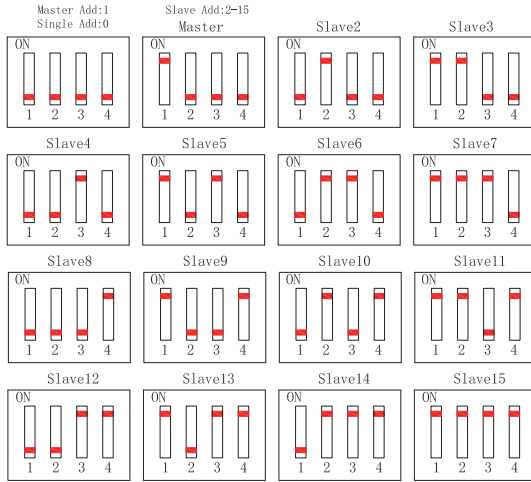

Figure 16 Dial Address

Step 9:

Connect the parallel COM. cable (yellow network line). Each battery has 2PCS RS485B port for parallel communication, 1PCS RS485A and 1PCS CAN port for inverter or other device. RS232 port only used for host software and update the firmware. DRY port connect as sample picture.you can use DRY port 1, port 2.

When the Battery pack has DRY PORT connect. PORT1, PORT 2 will connect to your external device. Set the output logic separately, please contact the battery supplier for processing. There is a sample for use.

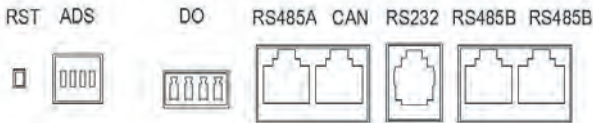

Figure 17 Dry Contact

Note: OTP: over temperature protect
SCP: short circuit protect

UTP: under temperature protect
OVP: Over voltage protect

No.	Functional Description	Remark
1	DO1 out +	PORT1: Normal is open,when BMS start OTP,UTP,SCP,it is closed
2	DO1 out -	
3	DO2 out +	PORT2: Normal is open, when BMS start OVP,it is closed
4	DO2 out -	

Figure 18. this is 4bits coder and communication port. CAN port and RS485A port can be selected as the same time.

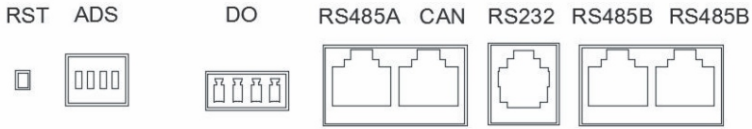

Figure 18 RS485 and CAN Port

		RS485B-8P8C		RS485B-8P8C	
		RJ45		RJ45	
Parallel communication		1,8	RS485-B	9,16	RS485-B
		2,7	RS485-A	10,15	RS485-A
		3,6	GND	11,14	GND
		4,5	NC	12,13	NC
External communication		RS485A port		CAN port	
		RJ45		RJ45	
		1,8	RS485-B1	9,10,11,14,16	NC
		2,7	RS485-A1	12	CAN- L
		3,6	GND	13	CAN-H
Communication with host computer		RS232 RJ11			
		RJ11		RJ11	
		1	NC	4	RX
		2	NC	5	NC
		3	TX	6	NC

NOTE: The output connected to the communication cable with a waterproof plug is listed according to the order requirements, which are customized products, and are not listed here.

Step 10:

Process of battery turn-on & turn-off. Confirm that the operation is correct, and the battery function can be turned on after the cable connection is correct, and You can press power switch (ON/OFF) 3 seconds, then the battery start working, it enter standby mode (if there is no power switch, please press the RESET button 3-6 seconds, like as follow picture, LED indicate all running status and check it's self).

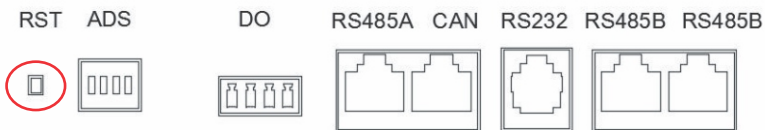

Figure 19 Reset Battery

Step 11:

Run the device, set the external charger or inverter, please set according to the corresponding operation manual. Can not exceed the rated parameter requirements.

Battery Pack Parameters:

No.	Item	General Parameter		
1	Combination Method	25.6V	48V	51.2V
2	Rated Capacity (Ah)	100/150/200	100/150/200	100/150/200
3	Factory Voltage (V)	24-26	48-50	51-53
4	Rate power (Wh)	2560/3840/5120	4800/7200/9600	5120/7680/10240
5	Charging Voltage (max V)	29.2	54.75	58.4
6	Charging Current (max A)	0.5C	0.5C	0.5C
7	Float charge Voltage (V)	27.6	53.5	56.5
8	Discharge Cut-off Voltage (V)	≤22V	≤42V	≤44V
9	Max Discharging current (A)	1C	1C	1C
10	Charging Current limits (A)	20	20	20
11	Charge over Current protect (A)	160	160	160
12	Discharge over Current protect (A)	160	160	160
13	Internal resistance	≤60mΩ	≤60mΩ	≤60mΩ
14	Communication protocol	CAN/485	CAN/485	CAN/485
15	Host soft ware and communication protocol	RS232/485	RS232/485	RS232/485
16	Operation Temperature Range	Charge: 0~45°C		
		Discharge: -20~60°C		
17	Storage Temperature Range (recommend)	0~25°C		

Battery Pack Parallel Parameters:

No.	Item	General Parameter		
1	Combination method	25.6V	48V	51.2V
2	Rated Capacity(Ah) *Parallel	PACK	PACK	PACK
3	Factory Voltage (V)	24-26	48-50	51-53
4	Charging Voltage (max V)	29.2	54.75	58.4
5	Charging Current (max A)	0.2C	0.2C	0.2C
6	Float charge Voltage (V)	27.6	53.5	56.5
7	Discharge Cut- off Voltage (V)	≤22V	≤42V	≤44V
8	Max Discharging current (A)	0.5C(total)	0.5C(total)	0.5C(total)
9	Charging Current limits (A) *Parallel	20	20	20
10	Charge over Current protect(A) *Parallel	160	160	160
11	Discharge over Current protect(A)	160	160	160
12	Internal resistance	≤60mΩ	≤60mΩ	≤60mΩ
13	Communication protocol	CAN or 485	CAN or 485	CAN or 485
14	Host soft ware and communication protocol	RS232/485	RS232/485	RS232/485
15	Operation Temperature Range	Charge: 0~45°C		
		Discharge: -20~60°C		
16	Storage Temperature Range(recommend)	0~25°C		

Step 12:

Monitors are in running status, and record all parameters, if any mistake, please record it. After start the system, every battery is on, and LED indicate these status.

A : LED indicates



Figure 20 LED

Chart 1: Battery Status

ON/OFF	RUN	ALARM	SOC					

Chart 2: Battery Capacity

Status	Charge						Discharge					
soc (%)	L6	L5	L4	L3	L2	L1	L6	L5	L4	L3	L2	L1
0-16.6%	OFF	OFF	OFF	OFF	OFF	Flash2	OFF	OFF	OFF	OFF	OFF	Light
16.6-33.2%	OFF	OFF	OFF	OFF	Flash2	Light	OFF	OFF	OFF	OFF	Light	Light
33.2-49.8%	OFF	OFF	OFF	Flash2	Light	Light	OFF	OFF	OFF	Light	Light	Light
49.8-66.4%	OFF	OFF	Flash2	Light	Light	Light	OFF	OFF	Light	Light	Light	Light
66.4-83%	OFF	Flash2	Light	Light	Light	Light	OFF	Light	Light	Light	Light	Light
83-100%	Flash2	Light	Light	Light	Light	Light	Light	Light	Light	Light	Light	Light
RUN LED	Light						Flash (Flash3)					

Chart 3: LED Flash and Buzzer Mode (Off by Default)

Mode	ON	OFF
Led Flash1	0.25S	3.75S
Led Flash2	0.5S	0.5S
Led Flash3	0.5S	1.5S

Chart 4: LED Flash Mode

System status	Run status	ON/OFF	RUN	ALM	SOC						REMARK	
		●	●	●	●	●	●	●	●	●		
Power off	Sleep	OFF	OFF	OFF	OFF	OFF	OFF	OFF	OFF	OFF	OFF	All led off
Stand by	Normal	Light	Flash1	OFF	Lighting for SOC						Stand by mode	
	Alarm	Light	Flash1	Flash3	Lighting for SOC						Low volt alarm	
Charge	Normal	Light	Light	OFF	Lighting for SOC (The LED flash2, while it is the high SOC) Alarm LED do not flash, when the BMS into OVP mode.							
	Alarm	Light	Light	Flash3	Lighting for SOC							
	OVP	Light	Light	OFF	Light	Light	Light	Light	Light	Light	No charge in, into standby	
	OTP,OCP Fail	Light	OFF	Light	OFF	OFF	OFF	OFF	OFF	OFF	OFF	Stop charge
DisCharge	Normal	Light	Flash3	OFF	Lighting for SOC							
	Alarm	Light	Flash3	Flash3	Lighting for SOC							
	UVP	Light	OFF	OFF	OFF	OFF	OFF	OFF	OFF	OFF	OFF	Discharge off
	OTP,OCP,SCP, Invert connect, Fail	Light	OFF	Light	OFF	OFF	OFF	OFF	OFF	OFF	OFF	Discharge off
Fail		OFF	OFF	Light	OFF	OFF	OFF	OFF	OFF	OFF	NO charge or discharge	

Step 13:

Stop running battery pack.

When it is necessary to stop the charging and discharging of the battery or trouble shooting, please stop the external equipment first, cut off the input and output circuits, and then press the power-off switch for each battery.

Step 14:

Check the LCD display screen and monitor the working status of the BMS.

5 button LCD:

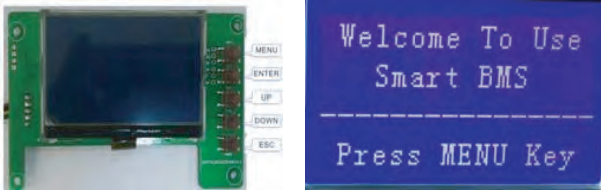

Figure 21 Button and LCD

Main menu page

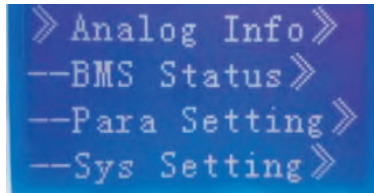

Figure 22 Main Menu

After BMS is activated, will show the welcome screen. Press the **MENU** button to enter the main menu page. As shown in the figure below.

Parameters Acquisition press **ENTER** key will enter into the page of "Battery Parameters Acquisition", As shown in the figure below.



Figure 23 Main Parameters

Battery status page

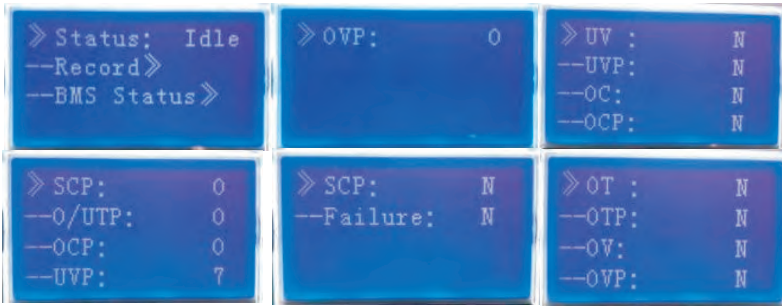

Figure 24 Battery Status

When the cursor "»" is point to "Battery Status", press **ENTER** key, will enter into the page of "Battery Status", As shown in the figure below:



Figure 25 Baud Rate

Screen can not set parameters Baud Rate: 9600, Can not be set.

Key description:

1. SW1----NEMU SW2----ENTER SW3----UP SW4----DOWN SW5----ESC.
2. Each item is"»" "or"--" as a beginning, among them " » "shows the current cursor position, press UP or DOWN key can move the cursor position. With"»" "end of the project, the content of the said project has not shown, press ENTER key can enter the corresponding page.
3. Press ESC key can be returned at the next higher level directory, In any position, press NEMU key can return to the main menu page.
4. When BMS enter sleep mode, press any key, can activate the screen.
5. Enter standby mode, with no keystrokes 1 minute later, LCD will enter Shutdown mode press any key, screen can be activated.

6 Error Code Information

	DESCRIPTION	ERROR CODE	SOLUTION
ALARM			
1	Cell Over Voltage	Cell OV	Will not affect the normal use, discharge to clear alarm
2	Cell Under Voltage	Cell UV	Will not affect the normal use, charge to clear alarm
3	Pack Over Voltage	Pack OV	Will not affect the normal use, discharge to clear alarm
4	Pack Under Voltage	Pack UV	Will not affect the normal use, charge to clear alarm
5	Charge Over Current	CHG OC	Will not affect the normal use, discharge to clear alarm
6	DisCharge Over Current	DSG OC	Will not affect the normal use, charge to clear alarm
7	Charge Over Temperature	CHG OT	Will not affect the normal use, lower temperature to clear alarm
8	DisCharge Over Temperature	DSG OT	Will not affect the normal use, lower temperature to clear alarm
9	Charge Under Temperature	CHG UT	Will not affect the normal use, rise temperature to clear alarm
10	DisCharge Under Temperature	DSG UT	Will not affect the normal use, rise temperature to clear alarm
11	Environment Over Temperature	ENV OT	Will not affect the normal use, lower temperature to clear alarm
12	Environment Under Temperature	ENV UT	Will not affect the normal use, rise temperature to clear alarm
13	MOS Over Temperature	MOS OT	Will not affect the normal use, lower temperature to clear alarm
PROTECTION			
14	State of Charge Low	SOC Low	Charge
15	Cell Over Voltage Protection	Cell OVP	Wait till release to OVP or discharge
16	Cell Under Voltage Protection	Cell UVP	Wait till release to UVP or charge
17	Pack Over Voltage Protection	Pack OVP	Wait till release to OVP or discharge
18	Pack Under Voltage Protection	Pack UVP	Wait till release to UVP or charge
19	Charge Over Current Protection	CHG OCP	Automatic disarming after 1min or discharge
20	Discharge Over Current Protection	DSG OCP	Automatic disarming after 1min or charge
21	Short Circuit Protection	SCP	Automatic disarming after remove loads or charge
22	Charger Over Voltage Protection	Charger OVP	Stop Charge, remove loads
23	Charger Inversed	Charger Inversed	Stop Charge, remove loads, connect the wire correctly
24	Charge Over Temperature Protection	CHG OTP	Stop Charge till recover under OTP
25	Discharge Over Temperature Protection	DSG OTP	Stop discharge till recover under OTP
26	Charge Under Temperature Protection	CHG UTP	Stop Charge till recover under UTP
27	Discharge Under Temperature Protection	DSG UTP	Stop discharge till recover under UTP
28	MOS Over Temperature Protection	MOS OTP	Stop Charge and discharge till recover under MOS OTP or check if the MOS is damaged
29	Environment Over Temperature Protection	ENV OTP	Stop Charge and discharge till recover under ENV OTP
30	Environment Under Temperature Protection	ENV UTP	Stop Charge and discharge till recover under ENV UTP
31	Fully Charge	Fully	Stop Charge
FAULT			
32	Charge MOS Fault	CHG MOS Fault	Hardware fault or poor connection, contact seller to find solution
33	Discharge MOS Fault	DSG MOS Fault	Hardware fault or poor connection, contact seller to find solution
34	NTC Fault	NTC Fault	Hardware fault or poor connection, contact seller to find solution
35	Cell Fault	Cell Fault	Hardware fault, contact seller to find solution
36	Sampling Fault	Sampling Fault	Hardware fault or poor connection, contact seller to find solution
37	CCB Fault	CCB Fault	Hardware fault or poor connection, contact seller to find solution

7 Host Soft Operation

When the equipment manufacturer confirms that it is necessary, it can authorize to provide the customer with the host software and operating instructions.

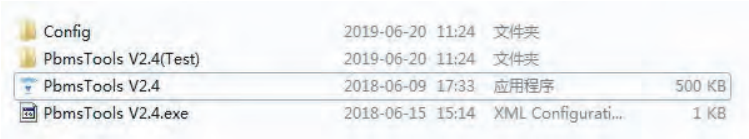

Figure 26 File Location

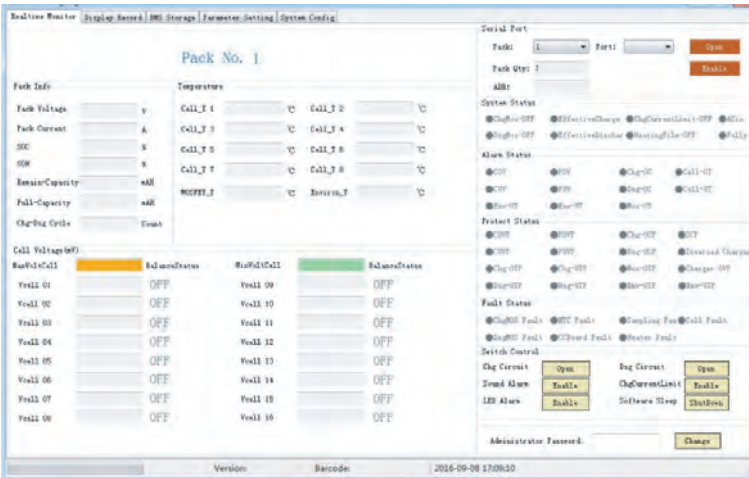

Figure 27 Main Window

8 Trouble Shooting

- Battery pack stops work.

A. Turn on switch; be sure it is ON; if battery is low SOC; it needs to charging in.

B. Battery pack low volt or enter sleep mode, there you will press down RST button 3-6 seconds, or charging in.

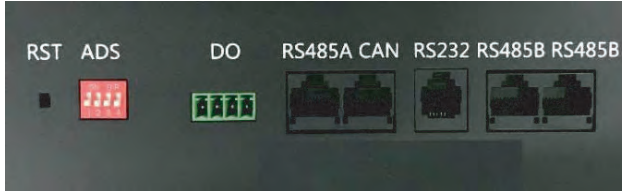

Figure 28 Reset for Trouble Shooting

- No communication, inverter can not received any DATA from BMS.

A. Check whether if communication cable is OK, check RJ45 PIN,

CAN: PIN4=CAN H, PIN5=CAN L,

RS485A: PIN2=485-A, PIN1=485-B.

B. Replace the communication cable. Please give feedback to the dealer and replace.

C. Check inverter or other device which connect to BMS, update the firmware.

D. If the communication function needs to be upgraded, please consult the agent or manufacturer.

E. Confirm your inverter and battery protocol are correct, Different protocol or different connection will make a mistake.

- Battery pack report SOC is mistake.

A. Inverter received Data from Master BMS, but it's SOC < total SOC, as: 9PCS packs has 1800Ah, but inverter read DATA is 1600Ah. So you may check any one is disconnected. Check RS485B COM. Cable (yellow), RS485 communication cable, replace the cable which is broken.

RJ45 PIN:

CAN: PIN4=CAN H, PIN5=CAN L,

RS485A: PIN2=485-A, PIN1=485-B.

B. SOC DATA has large tolerance.

Discharge the battery completely first, then charge it fully with a small current, and learn to discharge. Any battery is mistake, we advice you read the BMS Data (When we authorize the terminal to use)with host software. Then we reset the BMS and calibration.

- How to turn on the Battery to discharge.

We recommend method is:

A: reset the single battery's BMS, LED will flash and start work.

B: turn on the power switch on the bottom/front panel.

C: turn on power switch in the combiner box.

WARNING: The operating parameters of the equipment cannot exceed the rated working voltage and current of the battery, exceed the rated volt and current, Can cause damage to the battery or other failures.

Inverter or other external device can not connect the battery. We recommend method is.

- A. Check whether the working parameters of the device and battery are appropriate, and improper parameters cannot be matched.
- B. When the device is turned on, the current is too large, resulting in battery protection. At this time, you should be able to see the LED flashing from the battery panel. In this case, you can adjust your equipment parameters or contact the dealer to solve.
- C. It is necessary to update BMS parameters and match the device, then Reset BMS and restart your device.
- D. Replace bad battery.
- E. There is a bad battery, need to replace, please contact your supplier, need professional installers to operate it. We recommend replacing whole or choose battery has same voltage and same specification.

NOTE: When replacing the cells, the same module needs to be replaced at the same time, and the voltage should be the same.

Need to replace spare parts or emergency maintenance.

Some parts can be obtained from the sales or agency, and the excess parts need to be purchased separately. Be careful, turn off the power switch before replacing.

Need to place some safety device for keep a safety environment.

You'd keep a safe case for battery and external device, Please place safety device, as: fire-fighting sand, fire-fighting blankets, fire-fighting water pipes, Install Monitor sound, light, electricity, smoke and other equipments.

8.1 Emergency process

8.1.1 The External Device Catches Fire and Explodes

- A. Under the condition of ensuring safety, non-operating personnel immediately move to a safe location.
- B. Under the condition of ensuring safety, the operator immediately cut off the external power supply of the equipment and the internal power supply.
- C. Use fire-fighting equipment (the fire-fighting sand, fire-fighting blankets, fire-fighting water pipes).
- D. If you cannot completely extinguish the fire, please call the local fire department for help.
- E. Keep the accident site data so that the source of the accident can be traced.

8.1.2 The Battery Catches Fire and Explodes

- A. Under the condition of ensuring safety, non-operating personnel immediately move to a safe location.
- B. Under the condition of ensuring safety, the operator immediately cut off the external power supply of the equipment and the internal power supply.
- C. Use fire-fighting equipment (the fire-fighting sand, fire-fighting blankets, fire-fighting water pipes).
- D. If you cannot completely extinguish the fire, please call the local fire department for help.
- E. Keep the accident site data so that the source of the accident can be traced.

NOTE: When replacing the cells, the same module needs to be replaced at the same time, and the voltage should be the same.

PMO-CTA-LFP-M88PW-User manual-V23B



MOTOMA[®]

Power into the Future

QUALITY CREATES BRAND
SERVICE ENHANCES VALUE



SHENZHEN MOTOMA POWER CO.,LTD.

📍 502, Bldg.N2, Tian An Cyber Park, FengGang, Dongguan, Guangdong, China

☎ +86-769-8216-3796

✉ info@motoma.cn

🌐 www.motoma.cn